



BIRDTEK

MANUFACTURING CORPORATION

Serving Health Care

Manufacturers & Exporters of Quality Veterinary Instruments

ANIMAL HEALTH

VETERINARY SURGICAL & DENTAL INSTRUMENTS CATALOGUE



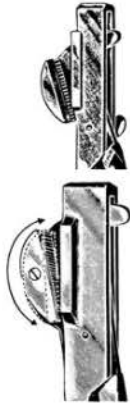

BT1-001
White's Modified Emasculator with extra crushing area. Stainless steel. 12".

BT1-002
White's Modified Emasculator. Stainless steel. 8". (not pictured)

BT1-003
Even Crush Emasculator. Extra crushing area moves as crushing takes place. Stainless steel. 12"



BT1-007
Small Emasculator.
Stainless steel. 7 1/2"



BT1-004
Sand's Castrator. Crushing only.
Stainless steel.



BT1-008
Reimer Emasculator.
BT1-009
Reimer Emasculator.

This very popular emasculator has a double crushing part. The cutting lever is worked separately. This allows extra time for crushing action and diminishes afterbleeding. stainless steel. 12 1/2"

BT1-010
Hauptner Reimer Emasculator. Chrome.



BT1-005
Hausman Standard Emasculator.
Stainless steel. 12"



BT1-011
Bloodless Castrator
23cm
(for Lambs and Rabbit)



BT1-006
Frank's Emasculator.
Stainless steel. 7 1/2"



BT1-012
Castrator Heavy Duty with Pin size 9"



BT1-013
Serra Modified Emasculator. Hauptner's finest emasculator, excellent for equine work. Chrome. 14".

BT1-014
Serra Modified Emasculator. Stainless steel. 14"

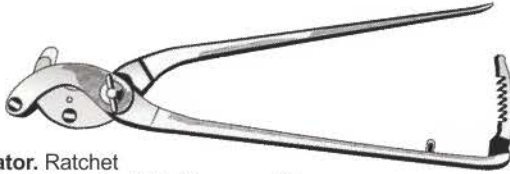

BT1-015
Serra Emasculator. Ratchet holds emasculator lock, as in J-37. Chrome. 14".

BT1-016
Serra Emasculator. Stainless steel.



BT1-017
Newberry Castrating Knife. Stainless steel. 10 1/2"L. (Blade is non-replaceable.)



BT1-020
Ecrasseur. This is the popular ratchet type ecrasseur by Chassaignac. Stainless steel. German-made. 19".



BT1-021
Reimer Emasculator s/s M09. 12 1/2"L. European made.



BT1-022
Serrated, Curved Spay Scissors. 12".
Serrated, Curved Spay Scissors. 16" for flank approach in spaying heifers.



BT1-018
JorVet Emasculatome. With cord stop for bloodless castration. Includes wrench on all models.
Emasculatome. 9"
Emasculatome. 12"
Emasculatome. 14"
Emasculatome. 16"
Emasculatome. 19"



BT1-019
Knee Brace for large models.



BT1-023
Castration Kit. Scalpel handle together with 6 sterile scalpel blades. On a display card
22 blades with large red nylon handle
12 blades with large red nylon handle



BT1-024
Frank Emasculator
Stainless German 9"



BT1-025 Burdizzo Castrator, Baby 9"
BT1-026 Burdizzo Castrator, Small 12"
BT1-027 Burdizzo Castrator, Medium 13"
BT1-028 Burdizzo Castrator, Large 15"
BT1-029 Burdizzo Castrator, Indian 19"



BT1-034
Castrating knife Set Metal handle covered with solid wooden pieces, contains five knives.



BT1-030
Plain Emasculator,
Stainless German 12"



BT1-035
Reimer Emasculator
For Crushing Only



BT1-031
Twitches; 30" Long; Rope twitch



BT1-036
Hetzl Emasculator



BT1-032
Twitches; 30" Long; Stainless chain twists in both directions



BT1-033
Castrating knife spay/Hoe, 3"



BT1-037
Emasculator in Plastic Body



BT1-038
Marking Ring Applicator Stainless Steel



BT1-039
Marking Ring Applicator



BT1-040
Heavy Duty Marking Ring Applicator



BT1-041
Bull Holder
Size 15"



BT1-042
Bull Holder with chain
Size 12"



BT1-043
Prolapse Needle
7cm, 8cm, 10cm, 13cm



BT1-044
Bull Nose
Ring Applicator



BT1-045
Bull Nose Ring
Applicator With
Vertical Opening Delivered
With A Break-off Screw



BT1-046
Bull Nose Ring Applicator With
Vertical Opening Delivered
With A Break-off Screw
Size 13"



BT1-047
Bull Nose Ring Applicator
For Bull Rings Size 12"



BT1-048
With Pig Staples Applicator
Made of Aluminium With
Adjustment Screw Size 6"



BT1-053
Bull Holder with spring
Size 7cm, 11cm



BT1-049
Bull Holder Harm's With
Rowel Slide Size 18 cm



BT1-054
Automatic Lock Easily Released
Bull Lead, Aluminum Size 3"



BT1-050
Bull Holder With Push
Button Lock Size 18 cm



BT1-055
Automatic Lock Easily Released
Bull Lead Brass Size 4"



BT1-051
Bull Holder With Spring
Size 7 cm, 11 cm



BT1-056
Bull Leader to Catch the Ring
and to Facilitate the Animal
Manipulation Size 4"



BT1-052
Bull Holder with spring
Size 7cm, 11cm



BT1-057
Bull Holder Continental
Tong Pattern, Size 43cm



BT1-058
Bull Holder with spring
Size 7 cm, 11 cm



BT1-062
Heavy Duty Bull
Holder without chain
Size 20cm 22cm



BT1-059
Bull Holder with Side Gripe
Size 20cm 22cm



BT1-063
Bull Holder Harm's With
Slide Adjuster made of S.S
Size 18 cm



BT1-060
Heavy Duty Bull
Holder with chain
Size 20cm 22cm



BT1-064
Milk Sucking Preventor Plier
Available In Red Colour Also
Size 18"



BT1-065
Pig Nose Ring Applicator
Size 10"



BT1-061
Heavy Duty Bull
Holder with chain
Size 20cm 22cm



BT1-066
Bull Ring Halter
Size.....



BT1-067
Bull Ring
Stainless Steel
Sizes are 55mm
and 65mm



BT1-072
Bull Ring Stainless Steel
60mm, 70mm, 80mm,
90mm, 100mm

BT1-068
Bull Ring
Stainless Steel
Sizes are 55mm
and 65mm



BT1-069
Bull Ring Copper
60mm, 70mm, 80mm,
90mm, 100mm



BT1-073
Bull Ring Nickel Plated
60mm, 70mm, 80mm,
90mm, 100mm



BT1-070
Bull Ring Stainless Steel
60mm, 70mm, 80mm,
90mm, 100mm



BT1-071
Bull Ring Brass
60mm, 70mm, 80mm,
90mm, 100mm



BT1-074
Bull Ring Brass
60mm, 70mm, 80mm,
90mm, 100mm



BT1-075
Hoof Forceps



BT1-081
Shoe Puller to Grab Hold
of The Shoe Removal
Size 14"



BT1-076
Hoof Clamp
Black Coated



BT1-082
Diamond Shoe Puller & Spreader Round
Knobs on of Handles Size 15"



BT1-077
Round Hoof Tester
Size 13"



BT1-083
Black Steel Crocodile Plier With
Plastic Coated end (clincher)
Size 30cm



BT1-078
Hoof Tester Round Large
Size 18"



BT1-084
Black Steel Crocodile
Plier (clincher) Size 30cm



BT1-079
Shoe Puller
Size 12"



BT1-085
Diamond Nail Puller
Size 30cm



BT1-080
Diamond Farrier Nippers
Size 14"



BT1-086
Nail Nipper
Size 30cm



BT1-087
Professional Hoof Nipper With
Wide Opening Size 30cm



BT1-088
Diamond Farrier
Clincher Size 30cm



BT1-089
Foot Rotshear with lock pin
Size 9"



BT1-090
Foot Rot Shear
Size 9"



BT1-091
Sheep Hoof Cutter
Size 9"



BT1-092
Claw Cutter
Size 17"



BT1-093
Hoof Crease nail puller 12" (30cm)
stainless. for the removal of nails
especially when worn down inside
the grooves of the shoe.



BT1-094
shoe puller-spreader. 12" (30cm) stainless.
to remove the shoes or also to adjust a
shoe by spreading it of a better fit.



BT1-095
Hoof nipper or trimmer (13 1/2") 34cm stainless for
gentle trimming of the hoof.



BT1-096
clinch cutter. 6" double ended tool for opening the clinches
to reduce hoof wall damage during shoe removal. Beveled
on inside edge for closer cutting. Stainless. Other end is



BT1-097
Steel Hoof Trimmer. Popular compound action steel
model, with extra sharp blades that are replaceable.
Green with black handle grips. Suggested for use with
cattle. Size 40cm, 50cm



BT1-098
Hauptner Hoof Tester.
14 1/2".



BT1-099
JorVet Standard Hoof Tester.
stainless steel. 13".



BT1-100
Adjustable Hoof Tester. This sturdy model hoof tester has jaws of stainless steel and seven adjustments for every size hoof.



BT1-101
large Hoof Tester.
Heavy-duty. Stainless Steel. 13".



BT1-102
Extra Large Hoof Tester. 21". Max jaw opening is 20cm (8") which is much larger than standard tester. jaw teeth are large cleats for better hold. Stainless.



BT1-103
Ryding Hoof Tester. New design allows for adjustable jaws over entire hoof surface. The jaws remain parallel for more even and steadier diagnostic pressure. the handle accommodates one-handed use, leaving the other hand free to hold the leg or for positioning the hoof. stainless steel. patented.



BT1-104
Hauptner Hoof Knife. For the veterinarian who wants the very best. Small curl, ebony handle right or left curve. Blade 3/8" W x 2 1/2"L.

BT1-105 Hoof Knife. Left hand.

BT1-106 Hoof Knife. Right hand.



BT1-107
Right Curve Hoof Knife with brown wooden handle. Blade 5/8" W x 2 3/4"L.

BT1-108
Left Curve Hoof Knife with brown wooden handle. Blade 5/8" W x 2 3/4"L.



BT1-109
Swiss Hoof Knife. Length 7"

BT1-110
Folding Hoof Knife combined with hoof pick. Handy pocket size. Length 3"



BT1-111
Hoof Pick. Length 7"



BT1-112
Hoof Buffer.

BT1-113
Hauptner Hoof Knife Hone. Especially developed for hoof knives and will sharpen inside of curl.



BT1-114
Economy Hoof Knife Set.





BT1-115
Hoof Knife, Curved Blade,
Polished Wooden Grip



BT1-116
Hoof Knife, Extra Long Shaft,
Polished Wooden Grip



BT1-117
Hoof Knife, Narrow Blade,
Fine Wooden Grip



BT1-118
Hoof Knife, Wide Blade,
Fine Wooden Grip



BT1-119
Hoof Knife, Double Edged,
Length 7.5", Stainless Steel,
Polished Wooden Grip



BT1-120
Hoof Knife, Double Edged,
Small Size 6.5", Stainless Steel,
Polished Wooden Grip



BT1-121
Hoof Knife with small curl, double edge.
Blade 5/8"W x 2 3/4"L. Size 7"



BT1-122
Hoof Knife High quality Swiss-made instrument
with small curl, right or left curve.
Blade 5/8"W x 2 1/2"L. Size 7"

BT1-123 Hoof Knife Left hand.
BT1-124 Hoof Knife Right hand.



BT1-125 Hoof Knife Same as only featuring narrow 3/4"
blade, right or left curved. 2 1/2"L. Size 7"
BT1-126 Hoof Knife Left hand.
BT1-127 Hoof Knife Right hand.



BT1-128
Oval Hoof Knife



BT1-129
Hoof Searcher. Blade 2 1/2"L.



BT1-130
Foot-Rot Hoof Shear. Heavy handles
as illustrated, with strong spring and
safety clip. Specially designed tempered
steel serrated blades. Stainless steel.



BT1-131
Hugh's Angled Hoof Groover. This hoof groover
has an elliptical doughnut-shaped working end.
Elliptical opening is 2cm x 1cm. The bottom portion
is sharpened. it is great for digging out or curing
hoof abscesses. Stainless steel handles. 6 1/4"
(16cm) L.



BT1-132
Hugh's Straight Cutting Head Hoof Groover.



BT1-133
Small Loop Hoof Abscess Knife. Designed to curette out the smallest of abscess with this very sharp, but small loop. Ergonomic shaped wood handle.



BT1-134
Special Hoof Knife, Left
Size 8"



BT1-135
Special Hoof Knife, Right
Size 8"



BT1-136
Rasp without Handle
Size 12"



BT1-137
Rasp Barness Dehorner
with Wooden Handle
Size 12"



BT1-138
Rasp Barness Dehorner with
Metallic Handle and also
available in wooden handle
Size 12"



BT1-139
Rasp Barness Dehorner with
Metallic Handle and also
available in wooden handle
Size 17"



BT1-140
Oval Hoof Knife,
Available in wooden handle,
can be used left or right handed



BT1-141
Oval Hoof Knife,
Available in wooden handle,
can be used left or right handed.
Extra long shaft makes it easier
and more accurate to use



BT1-142
Hoof Parer
Size 14"



BT1-143
Hoof Rasp, Size 14"
long 3/4" wide



BT1-144
Mame Comb
P.U. 12
Small toothed, aluminium mane
comb with hoof pick.



BT1-149
Thinning Scissors
with curved blades,
heavy model, S.S.



BT1-145
Mame Thinning Knife
brown
Folding stripping comb.



BT1-150
Trimming Scissors
With curved blade
and plasticized
grip, S.S.



BT1-146
Pocket-Knife
Multi-purpose stable
knife, with 5 parts,
S.S.



BT1-151
Hoof Pick
assorted - P.U. 25
Metal with moulded
plastic handle.



BT1-147
Thinning Scissors
with curved blades,
small model, S.S.



BT1-148
Mane Thinning Scissors
S.S. & plasticized grip



BT1-152
Clipper Both Sided Thin
& Wide Teeth Size 8"
Silver



BT1-156
Hand sheep clipper
Size 8" Silver



BT1-153
Hand sheep clipper
with wooden handle
Size 8"



BT1-157
Aluminium Mane Comb
with Wooden Handle
Size 8" Silver



BT1-158
Aluminium Jockey
Mane Comb
Size 4"



BT1-154
Hand sheep clipper
Size 8"



BT1-159
Aluminium Mane Comb
Size 8" Silver

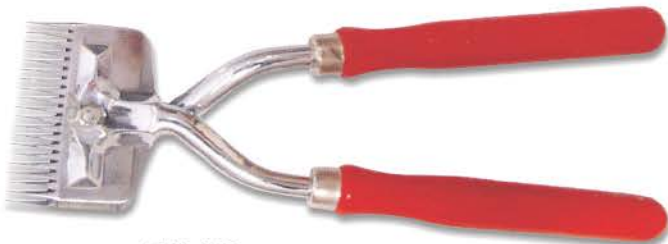

BT1-155
Hand sheep clipper
with wooden handle
Size 8" Silver



BT1-160
Aluminium Mane Comb
Size 4"



BT1-161
Mini Hog Catcher
Rubber Grips
Size 18"



BT1-162
Pig Holder S.S
60cm, 180cm
200cm, 100cm



BT1-163
Pig Holder S.S
60cm, 180cm
200cm, 100cm



BT1-164
Hog Catcher with
Rubber Grips
60cm, 180cm
200cm, 100cm



BT1-165
Pig Catcher
60cm, 180cm
200cm, 100cm



BT1-166
Calving Forceps, S.S
Size 24"



BT1-167
Balling Gun with Plastic Head
with or without spring
Size 18"



BT1-168
Calf Puller
Size 72"



BT1-169
Calving Assist Forceps S.S
Size 22"



BT1-170
Obstetric Forceps For Pig About
52cm Long, S.S Size 20"

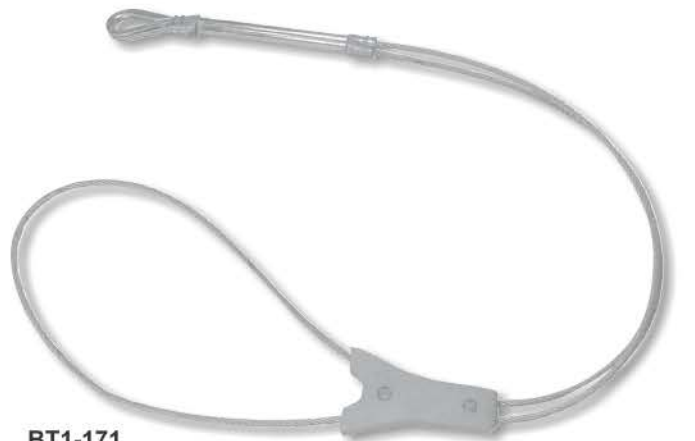

BT1-171
Calf Head Snare
Size 26", 40"





BT1-172
Obstetrical Chain
Size 26cm, 53cm, 75cm
150cm, 190cm



BT1-173
Pig Catcher S.S.
Size 18"



BT1-174
Pig Catcher
with Plastic Handle
Size 18"



BT1-175
Aluminum Mini
Hog Catcher
Size 20"



BT1-176
Pig Catcher
Size 18"



BT1-177
Professional Toe Nail Nipper 16cm
Compound Action,
Stainless Steel (Satin finish)



BT1-178
Professional Toe Nail Nipper 16cm
Compound Action, Stainless Steel
(Satin finish)



BT1-179
Professional Toe
Nail Nipper
Size 10cm, 11.5cm



BT1-180
Professional Toe
Nail Nipper
Size 10cm, 11.5cm



BT1-181
Toe Nail Nipper 14cm
Box Joint, Double Spring
Stainless Steel (Satin finish)



BT1-182
Professional Toe Nail
Nipper 16cm Double Action,
Stainless Steel (Satin finish)

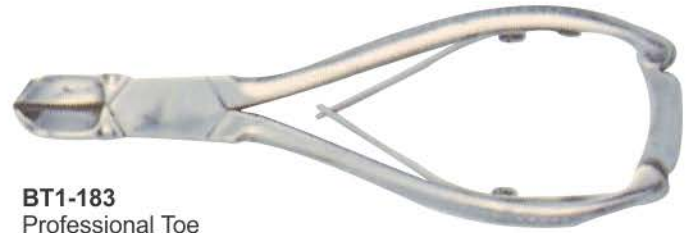

BT1-183
Professional Toe
Nail Nipper
Size 14cm



BT1-184
Professional Toe
Nail Nipper
Size 14cm



BT1-185
Nail Profiler (with grip)
14.5cm
Stainless Steel
(Powder coated)



BT1-186
Nail Profiler (with grip)
14.5cm
Stainless Steel (Powder coated)



BT1-187
Nail Profiler 14.5cm
Stainless Steel

BT1-188
White's Toenail scissors. 4".



BT1-189
White's Toenail scissors.
German-made. 4".



BT1-190
Cat Claw Scissors
Stainless steel. 3" (7.5c)



BT1-191
Bird Nail Trimmer.



BT1-192
JorVet Guillotine Style Nail Trimmer.
Size 5".



BT1-193
Two-Sided Nail File.
Size 6".



BT1-194
Heavy-Duty Nail Scissors.
Size 6 1/2".



BT1-195
Small Heavy-Duty Nail Trimmer.
Size 5"



BT1-196
New Style Nail Trimmer.
Size 6 1/2"



BT1-197
New Style Nail Trimmer.
Size 5 1/2" Lighter and
smaller version.



BT1-198
OB Caesarean Forceps.
 Stainless steel. Size 12"



BT1-199
Linde's Embryotomy Knife
 Stainless steel. Size 5"



BT1-200
Guenther's Embryotomy Knife
 Stainless steel. Size 2 1/2"



BT1-201
OB Saw Wire.
 10 meters.



BT1-202
Hauptner OB Wire.
 10 meters.

BT1-203
Thygesen's Fetatome.
 Size 33"
 10 meters.



BT1-204
Insertion Coil and Cleaning Brush
 for fetatomes.



BT1-205
Utrecht Fetatome
 Lightweight model
 Size. 38"



BT1-206
Moore Obstetric Chain 30", S.S or N.P
 Size 26cm, 53cm, 75cm, 150cm, 190cm



BT1-207
Obstetric Chain 60", S.S or N.P
 Size 26cm, 53cm, 75cm, 150cm, 190cm

BT1-208
Krey Hook
Stainless steel. Size. 8"



BT1-209
Ostertag's Blunt Eye Hook.
Stainless steel. Hole 5/8" dia.
Hook 3/4". Total 2".



BT1-210
Ruggeberg's Spring-Type
OB Double-Eye Hook.
Very easy to use. 5 1/2".

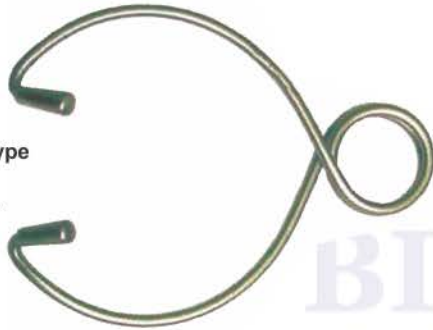

BT1-211
Vienna Double Blunt Eye Hook.
Stainless steel.
Hinged for easier placement. 5 1/2"

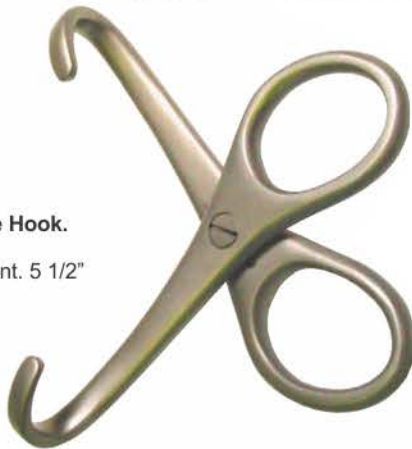

BT1-212
OB Wire Guide.
Size. 7".



BT1-213
Hauptner OB Wire Guide-
Size. 7".

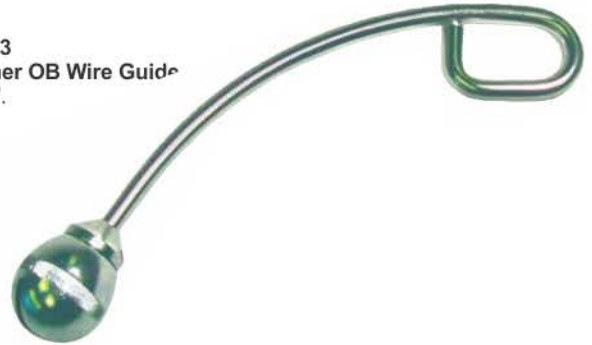

BT1-214
OB Wire Drop Guide.
Stainless steel. Size. 3 1/2".



BT1-215
Swedish OB Wire handle
and wire Container.



BT1-216
OB Wire Handle
Size 3 1/2"



BT1-217
Sutter Style OB Handle.
Knurled non-slip grip. 4".



BIRDTEK
MANUFACTURING CORPORATION

BT1-218
Pig Obstetrical Forceps.
Size. 23"

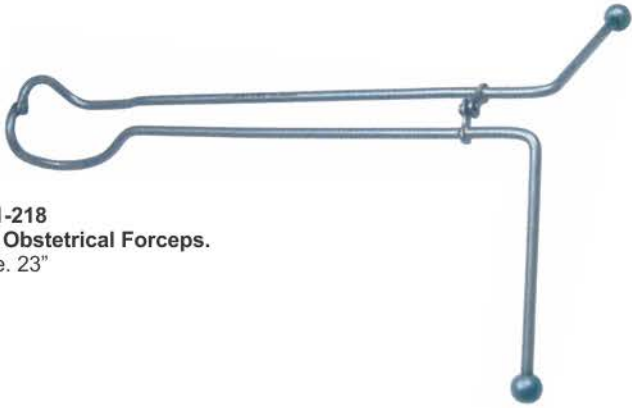

BT1-222
OB Chain Handle.
Stainless steel.



BT1-219
McLean Whelping Forceps.
for small breeds. Size. 8"



BT1-223
T-Bar OB Handle.
Size. 22cm.



BT1-220
Lyss OB Handle.
Stainless steel.
sold individually.
Size 3".



BT1-221
JorVet Calving Strap.
Size. 1"



BT1-224
Moore's OB Chain Handle.
Stainless steel.



BT1-225
Chain Handle.
Stainless steel with plastic
laminated handles for easier grip.



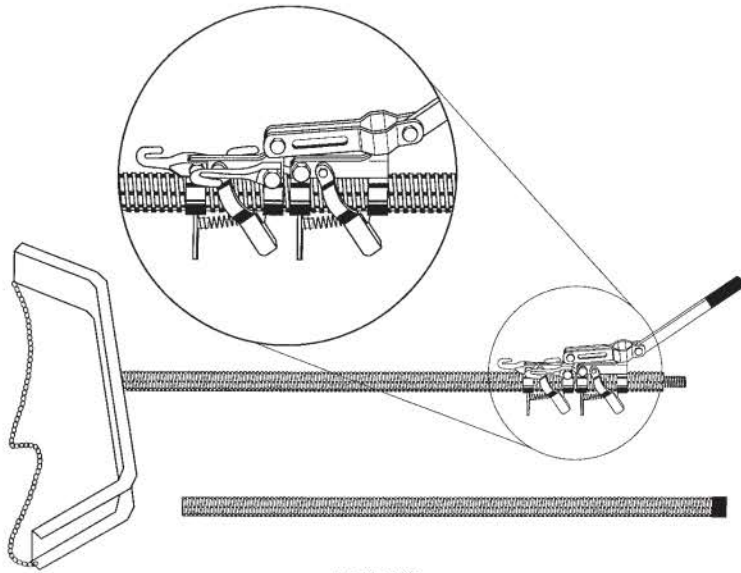

BT1-226
Hercules Fetal Extractor.



BT1-227
Tattooing Forceps
(B)



BT1-228
Tattooing Forceps
©, (D) Size 13"



BT1-229
Tattooing Forceps
(E)



BT1-230
Size 8"

Individual Replacement Parts are Available. OB Chains Sold Separately.



BT1-231
Wire Handle
Size 4"



BT1-232
Wire Handle
Size 4"



BT1-233
Tag Applicator Plier
Size 7"



BT1-234
Ear Notcher - A-type
Size 10"



BT1-235
Dean (Blumenthal) Rongeur, 6"
3 x 10mm bite tapered to 4mm,
slightly curved jaw

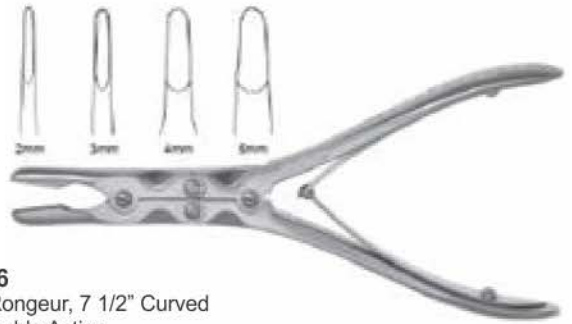

BT1-236
Ruskin Rongeur, 7 1/2" Curved
5mm, Double Action



BT1-237
Dental Extracting Forceps,
Upper Bicuspids,
Incisors and Roots, 286



BT1-238
Dental Extracting Forceps,
Upper Anteriors, Plit Beaks,
Serrated, 150A



BT1-239
Dental Extracting Forceps,
Lower Incisors, Cuspids, and
Bicuspid and Roots,
Universal, 151



BT1-240
Dental Extracting Forceps,
Upper and Lower Fragments
and Roots, 69



BT1-241
Dental Extracting Forceps,
Mead, Md4, Lower 1st,
2nd and 3rd Molars,
Universal



BT1-242
Dental Extracting Forceps,
Lower Roots, 74
English Pattern



BT1-243
Reynolds cap extractor,
Upper, 15" Long



BT1-244
Reynolds Cap Extractor
Lower, 15 1/2" Serrated



BT1-245
Reynolds Cap Extractor
Lower, 19" Long Serrated



BT1-246
Upper/Lower Separating Forceps for spreading or
seperating incisors or wolf teeth before extraction, 10" Long



BT1-247
Cow Horned Forceps
For extracting short or broken
incisors, 10 1/2" Long



BT1-248
Fragment Forceps For Removing
tooth splinters and roots,
10 1/2" Long



BT1-249
Three Prong Forceps For Extracting
remينات of pre-molars, 11" Long



A



B



C



D

BT1-250
Set of 4 Upper/lower Separating Forceps, Cow Horned Forceps,
Fragment Forceps, and Three Prong Forceps



BT1-251
Three Prong Root Forceps,
Left, 19"



BT1-252
Three Prong Root Forceps,
Right, 19"



BT1-253
Four Prong Root Forceps,
19"



BT1-254
Four Prong Root Pony Forceps,
12"



BT1-255
Incisor Forcep, Bulb Handle,
19"



BT1-256
Molar Forceps, Concave,
Long Jaw Box Joint, 19"



BT1-257
Spreader, 18 1/2",
Bulb Handle, Stainless Steel



BT1-258
Molar Spreader, 20",
Stainless Steel



BT1-259
Fulcrum Serrated, SS Forceps,
19"



BT1-260
Hewson's Tooth Forceps,
14"



BT1-261
Fragment Forceps, Long Needle
19"



BT1-267
Wolf Tooth Forceps
7" Long,
Stainless Steel



BT1-262
Incisor Forceps
14"



BT1-268
Wolf Tooth Forceps
7" Long,
Stainless Steel



BT1-263
Molar Root Fragment Forceps
19"



BT1-269
Fragment Forceps
8" Long,
Stainless Steel



BT1-264
Molar Forceps, 14" Long,
Right Angle



BT1-270
Wolf Tooth Forceps
7 1/2" Long,
Stainless Steel



BT1-265
Molar Forceps, 12" Long,
Right Angle



BT1-271
Wolf Tooth Forceps
9 1/2" Long,
Box Jointed



BT1-266
Wolf Tooth Forceps
7 1/2" Long,
Stainless Steel



BT1-272
Tooth Cutter



BT1-273
Tooth Cutter



BT1-274
Wolf Tooth Forceps



BT1-275
Wolf Tooth Forceps



BT1-276
Guenther's forceps
15cm (Tooth extracting forceps)
Parallel shape



BT1-277
Guenther's forceps
Oval shape



BT1-278
Wire Cutter



BT1-279
Equine Molar Cutter. Powerful compound action. Breakdown model for easy storage. stainless steel. 11 1/2" handle. 25"L.

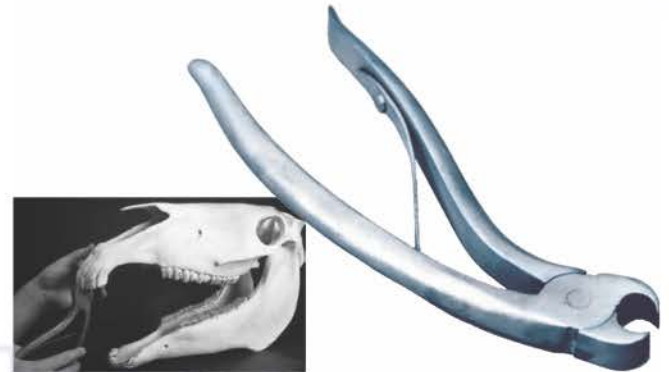

BT1-280
Deciduous Incisor Tooth Forceps. Spring handle increases holding power. Stainless steel. 20cm L.



BT1-281
Dental Tooth Punch. The Punch is used for removal of cheek teeth through a trephined hold into the sinus.
Tooth Punch. Straight.
Tooth Punch. Curved.



BT1-282
Dental Chisel with sliding bar or percussion handle. The working end has a notched "V". It work great for removing upper premolar hooks and lower rear molar hooks. stainless steel. 23"L. collapsed.

BT1-283
Recherdson
Size: M, L



BT1-284
Meet Hanging
Hook



BT1-285
Tongue
Depressor



BT1-286
Dental Picks



BT1-287
Dental Mirror



BT1-288
Dehorner



BT1-289
Calf Milk Whisk



BT1-290
20" Shaft, includes blade.



BT1-291
26" Shaft, includes blade.



BT1-292
Curved float blade with tungsten carbide chips, fits universal float.



BT1-293
Standard Dental Float with both straight and angled shaft with one interchangeable handle. 20"L.



BT1-294
House Float Angle Shaft only.

BT1-295
House Float Straight Shaft only.



BT1-296
House Float Interchangeable handle only.

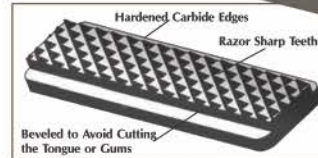
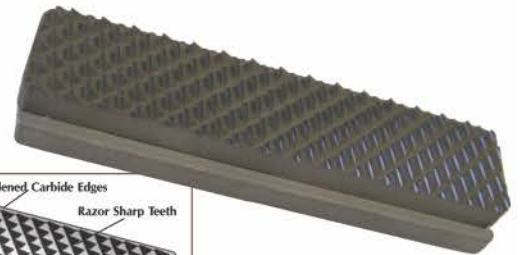

BT1-297
Float Blade. Medium grit.
BT1-298
Float Blade. Coarse grit.

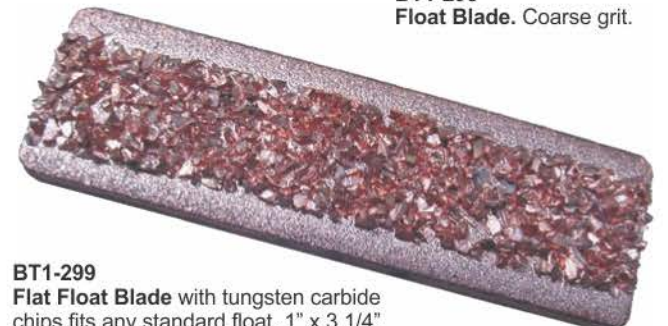

BT1-299
Flat Float Blade with tungsten carbide chips fits any standard float. 1" x 3 1/4".



BT1-300
Rear Molar Float. Specially designed for dropping over and onto the last molar and removal of hook that can develop on the caudal edge of that tooth. 13 1/2" L shaft.



BT1-301
Premolar Float. with short right angle shaft. Especially effective on premolar hooks and special "bit" requirement.



BT1-302
Angle or Obtuse Float. For use on upper arcade molars. 11 1/2" shaft.



BT1-303
Offset Molar Float. Excellent for rear molars. 13 1/2" shaft.



BT1-304
Straight Molar Float. 13 1/2" shaft.



BT1-305
Proctor Float makes it easy to float the first two premolars. Tungsten carbide chips. 12" L.



BT1-306
"S"-Shaped Hand Rasp. This is especially useful as a finishing tool on the upper premolars. Tungsten carbide 30cm L.



BT1-307
Pistol Grip Handle, only. 42cm.



BT1-308
Burgess Wolftooth Set.



BT1-309
Wolftooth Elevator.



BT1-310
Wolftooth elevator set.



BT1-311
Deluxe Wolf Tooth Elevator with ergonomic handle. 22cm L.

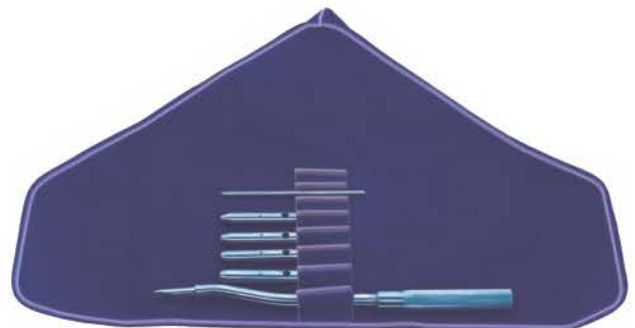

BT1-312
Deluxe Wolf Tooth Elevator Set.

BT1-313
 EquiVet Cheek Spreader



BT1-3134
 EquiVet Dental Mirror.
 "T" shaped handle. 19" length.



BT1-315
 EquiVet Dental Pick.
 "T" handle. Stainless steel. (48cm) 19"



BT1-316
 EquiVet Perpendicular Gingival Elevator.
 "T" handle. (48cm) 19"



BT1-317
 EquiVet Parallel Gingival Elevator.



BT1-318
 Set of all Three Gingival
 Elevators And Picks



BT1-319
 Dental Pick
BT1-320
 Perpendicular Gingival
 Elevator
BT1-321
 Parallel Gingival
 Elevator



BT1-322
 Compound Ronguer.
 Large 6mm bite
 slightly curved head.
 9" Length.



BT1-323
 Full Mouth Speculum; Includes 2
 Mouth plates & Biothane Halter

BT1-324
 Full Mouth Speculum; Includes 2
 Mouth plates & Leather Halter

BT1-325
 Mouth Plates;
 Set of 2 SS Mouth Plates



BT1-326
 Gum Bars



BT1-327
 Rubber Mouth Wedge;
 3 1/2" Long,
 1 1/2"- 1 7/8" Wedge



BT1-328
 Miniature Pony Size Wedge;
 3 1/4" Long,
 1 1/4"-1 5/16" Wedge



BT1-329
 Rubber Mouth Wedge
 Replacement Piece

BT1-330
 Miniature Rubber
 Replacement Piece



BT1-331
 Rubber Mouth Wedge

Stainless steel Plate

BT1-332

Miniature Rubber Mouth Wedge

Stainless Steel Plate



BT1-333

Heavy Dental Pick 15 1/2" Length,
 5/8" Width, 1/2" Tip Depth



BT1-334

Heavy Dental Straight Pick 16"
 Length, 5/8" Width, 1/2" Tip
 Depth



BT1-335

Dental Punch, 8mm Tip, 8" Long,
 3/4" Diameter Handle

BT1-336

Dental Punch, 12mm Tip, 8" Long,
 3/4" Diameter Handle



BT1-337

Dental Punch Set of Four, 12.5mm
 offset, 20mm offset, 20mm Curved,
 20mm Straight

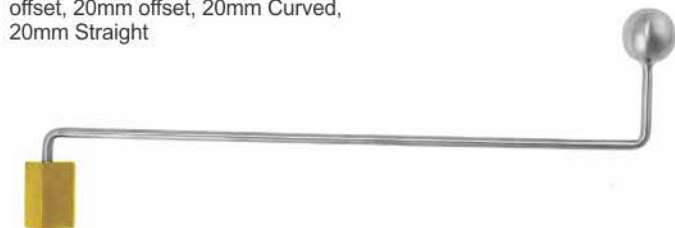

BT1-338

Dental Fulcrum, 3 different height
 aluminum heads

BT1-339

Dental Fulcrum, 4 different height
 aluminum heads



BT1-340

Rectangular Dental Fulcrums,
 2 fulcrums, 5/16", 3/8",
 7/16", 1/2"



BT1-341

Gracey Curette, 18" Long



BT1-342

Periodontal Probe, 15 1/2" Long,
 3mm, 6mm, 9mm, 12mm, 15mm,
 18mm, and 21mm Markings



BT1-343

Original Burgess Set,
 Two Tips: S, M., Cordura Case,
 Non-Slip Steel handle,
 Straight & offset extensions, Pick



BT1-348
Sims Uterine Curettes,
Sharp Malleable Shaft, 11", Size 00



BT1-349
Sims Uterine Curettes,
Sharp Malleable Shaft, 11", Size 0



BT1-350
Sims Uterine Curettes,
Sharp Malleable Shaft, 11", Size 1



BT1-351
Sims Uterine Curettes,
Sharp Malleable Shaft, 11", Size 2



BT1-344
Improved Burgess Set, Choice of
three tips: XS, S, M, or L, Improved
sculpted handle, Straight & offset
extensions, Cordura case, pick

BT1-352
Sims Uterine Curettes,
Sharp Malleable Shaft, 11", Size 3



BT1-345
Dental Probe Pointed Tip,
17 1/2" Long

BT1-353
Sims Uterine Curettes,
Sharp Malleable Shaft, 11", Size 4



BT1-346
Dental Explorer

BT1-354
Sims Uterine Curettes,
Sharp Malleable Shaft, 11", Size 5



BT1-347
Cheek Retractor



BT1-355
Sims Uterine Curettes,
Sharp Malleable Shaft, 11", Size 6





BT1-356
Wolf Tooth Elevator, 4mm Stainless Steel Tip, 6" Length, Hollow Handle

BT1-357
Wolf Tooth Elevator, 4mm Tip, 6" Length, Hollow Handle



BT1-358
Wolf Tooth Blade, 9mm Tip, 6" Length

BT1-359
Wolf Tooth Blade, 9mm Tip, 6" Length, 5 or More

BT1-360
Wolf Tooth Elevator, 9mm Tip, Sharp, 6 3/4" Length

BT1-361
Wolf Tooth Elevator, 9mm Tip, Sharp 6 3/4" Length, 3 or More



BT1-362
Wolf Tooth Handle Only



BT1-363
Gingival Elevators, Right



BT1-364
Gingival Elevators, Left



BT1-365
Elevators, 90 Degree angle down, 14"



BT1-366
Elevators, 90 Degree angle up, 14"



BT1-367
Elevators, 90 Degree angle left, 14"



BT1-368
Elevators, 90 Degree angle right, 14"



BT1-369 Winged Elevator, #4, Short Handle
BT1-370 Winged Elevator, #5, Short Handle
BT1-371 Winged Elevator, #6, Short Handle
BT1-372 Winged Elevator, #7, Short Handle
BT1-373 Winged Elevator, #8, Short Handle



BT1-374
Solid Bulb Handle Elevator, 4mm Stainless Steel Tip
Wolf Tooth Elevator, Length 4 3/4"
BT1-375
Solid Bulb Handle Elevator, 4mm Stainless Steel Tip
Wolf Tooth Elevator, Length 5 7/8"

BT1-376
Solid Bulb Handle Elevator, 5mm Tip, Stainless Steel, 4 3/4"
BT1-377
Solid Bulb Handle Elevator, 8mm Blunt Tip, Stainless Steel
Solid Handles, 6" Length



BT1-378
Winged Elevator Short Handle
1.2mm Backward Angle
BT1-379
Winged Elevator Short Handle
2mm Backward Angle
BT1-380
Winged Elevator Short Handle
3mm Backward Angle
BT1-381
Winged Elevator Short Handle
4mm Backward Angle

BT1-382
Winged Elevator Short Handle
5mm Backward Angle
BT1-383
Winged Elevator Short Handle
6mm Backward Angle
BT1-384
Winged Elevator Short Handle
7mm Backward Angle
BT1-385
Winged Elevator Short Handle
8mm Backward Angle

BT1-386
Winged Elevator Long Handle
1.2mm Backward Angle
BT1-387
Winged Elevator Long Handle
2mm Backward Angle
BT1-388
Winged Elevator Long Handle
3mm Backward Angle
BT1-389
Winged Elevator Long Handle
4mm Backward Angle

BT1-390
Winged Elevator Long Handle
5mm Backward Angle
BT1-391
Winged Elevator Long Handle
6mm Backward Angle
BT1-392
Winged Elevator Long Handle
7mm Backward Angle
BT1-393
Winged Elevator Long Handle
8mm Backward Angle

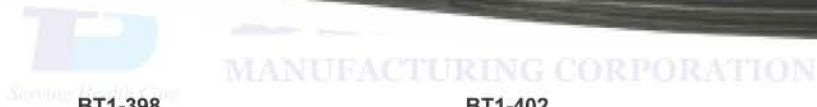

BT1-394
Winged Elevator Short Handle
1.2mm Forward Angle
BT1-395
Winged Elevator Short Handle
2mm Forward Angle
BT1-396
Winged Elevator Short Handle
3mm Forward Angle
BT1-397
Winged Elevator Short Handle
4mm Forward Angle

BT1-398
Winged Elevator Short Handle
5mm Forward Angle
BT1-399
Winged Elevator Short Handle
6mm Forward Angle
BT1-400
Winged Elevator Short Handle
7mm Forward Angle
BT1-401
Winged Elevator Short Handle
8mm Forward Angle

BT1-402
Winged Elevator Long Handle
1.2mm Forward Angle
BT1-403
Winged Elevator Long Handle
2mm Forward Angle
BT1-404
Winged Elevator Long Handle
3mm Forward Angle
BT1-405
Winged Elevator Long Handle
4mm Forward Angle

BT1-406
Winged Elevator Long Handle
5mm Forward Angle
BT1-407
Winged Elevator Long Handle
6mm Forward Angle
BT1-408
Winged Elevator Long Handle
7mm Forward Angle
BT1-409
Winged Elevator Long Handle
8mm Forward Angle

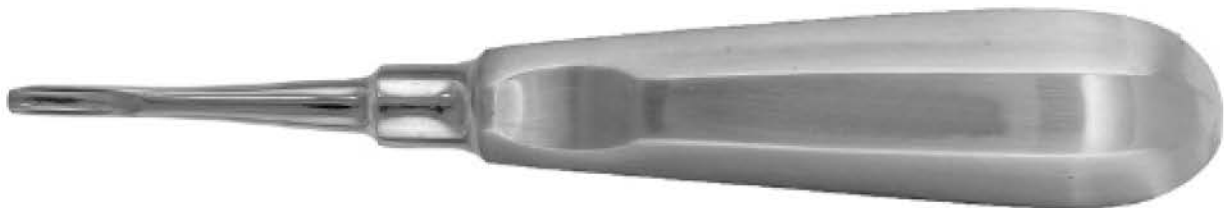

BT1-410
Luxation Elevator, Straight Tip
2mm, 5 3/4"
BT1-411
Luxation Elevator, Curved Tip
2mm, 5 3/4"

BT1-412
Luxation Elevator, Straight Tip
3mm, 5 3/4"
BT1-413
Luxation Elevator, Curved Tip
3mm, 5 3/4"

BT1-414
Luxation Elevator, Straight Tip
4mm, 5 3/4"
BT1-415
Luxation Elevator, Curved Tip
4mm, 5 3/4"

BT1-416
Luxation Elevator, Straight Tip
5mm, 5 3/4"
BT1-417
Luxation Elevator, Curved Tip
5mm, 5 3/4"



Instruments case with 35 Instruments

BT1-418

Needle Holder Hegar-Olsen, Hard Metal, 14cm
 Needle Holder Mathieu, 14cm and 20cm
 Handle No 4, Handle No 3
 Retractor Gelpi, 18cm
 Wound retractor, 14cm
 Standard curette, 17cm
 Director, winged, 14.5cm stainless steel
 Double-end probe 14.5 cm and 16cm
 Anatomic forceps curved 13cm standard quality
 Anatomic forceps 18cm straight, standard quality
 Splinter forceps straight 11.5cm
 Anatomic forceps 13cm standard quality
 Surgical forceps 13cm standard quality
 wound retractor Senn-Miller 16cm
 Intestinal forceps straight 23cm, standard
 Towel forceps Backhaus 9cm standard quality
 Allis grasping forceps, 16cm
 Plaster of paris scissors 18 cm standard quality
 Standard Rongeur, 14cm
 Nail clipper for dogs 11cm, standard quality
 Mosquito pean curved 13cm, standard quality
 Mosquito pean straight 13 cm, standard quality
 Rochester pean straight 14 cm, standard quality
 scissors straight 14cm blunt/blunt, standard quality
 scissors straight 14cm pointed/blunt, standard quality
 Nursing scissors 14cm standard quality
 Standard suture scissors 10.5cm
 Standard straight, curved, blunt/pointed, hard metal, 14cm
 Cooper scissors 16cm, curved pointed/blunt, standard quality
 Cooper scissors 14cm, curved blunt/blunt, standard
 Needle holder mayo-Hegar, tungsten, 13cm
 Kruuse Babcock's eye forceps
 instrument case, black, with 35 instruments

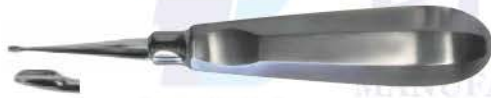

BT1-419
winged tooth elevator, 1mm



BT1-423
winged tooth elevator, 5mm



BT1-420
winged tooth elevator, 2mm



BT1-424
winged tooth elevator, 6mm

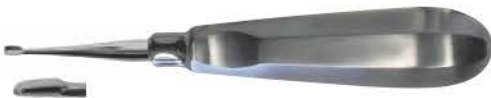

BT1-421
winged tooth elevator, 3mm



BT1-425
Straight Root Tip Pick
A straight root tip pick is most useful in working on deciduous teeth that need to be removed.



BT1-422
winged tooth elevator, 4mm

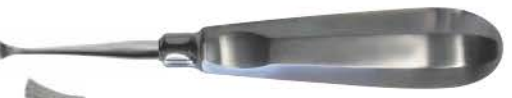

BT1-426
Periosteal Elevator
The elevator is used to lift the gum flap so that soft tissue is not encountered by a bur when removing bone, a must when removing canines.

BT1-427

winged elevator, small, stubby handle, 1mm



BT1-428

winged elevator, small, stubby handle, 2mm



BT1-429

winged elevator, small, stubby handle, 3mm



BT1-430

winged elevator, small, stubby handle, 4mm



BT1-431

winged elevator, small, stubby handle, 5mm



BT1-432

winged elevator, small, stubby handle, 6mm



BT1-433

winged elevator sizes 1-6mm, stubby (shorter length and larger diameter) handle. the stubby handle makes extraction so much safer as the user's finger can be placed at the instrument tip. the handle design is ideal for small or large hands. the set is supplied in a stainless steel autoclavable instrument holder/case. Each elevator is individually available.

winged elevator set w/small stubby handle, 1-6mm, steel box,

stainless steel instrument box 20.5x12x3 cm, autoclavable (without instruments)



BT1-434

Piece Winged Elevator Set

winged elevator sizes 1-6mm stubby (shorter length and larger diameter) handle. the stubby handle makes extracting so much safer as the user's finger can be placed at the instrument tip. the handle design is ideal for small or large hands. supplied in black pouch. each elevator is individually available.

winged elevator set small stubby handle sizes 1-6mm



BT1-435

Winged Elevator Set

winged elevator sizes 1-4mm or 1-6mm with standard handle, supplied in a black pouch. each elevator is individually available.

winged elevator set, 1-4mm

winged elevator set, 1-6mm

BT1-436
Luxator w/stubby handle, 1mm



BT1-437
Luxator w/stubby handle, 2mm



BT1-438
Luxator w/stubby handle, 3mm



BT1-439
Luxator w/stubby handle, 4mm



BT1-440
Luxator w/stubby handle, 5mm



BT1-441
1-5mm
Luxator w/stubby handle, kit with 5 luxators (1-5mm)
Luxators, sizes 1-5mm are very fine and sharp. them ideal for both canine and feline teeth. they are used and recommended by dental specialist's for cutting the periodontal ligament and expanding the alveolus (tooth socket). the stubby (shorter length and larger diameter) handle makes extraction so much safer as the users finger can be placed at the instrument tip.
Luxators are not elevator, we recommend winged elevator are used to elevate and extract the tooth.



Tooth Elevators
Elevator for supra-alveolar use in intra-alveolar extraction.
BT1-442 Tooth Elevator, Hylin, 2mm
BT1-443 Tooth Elevator, Hylin, 3mm
BT1-444 Tooth Elevator, Hylin, 4mm
BT1-445 Tooth Elevator, angled, right
BT1-446 Tooth Elevator, angled, left

Luxator
used to dislodge gingiva round the root of the tooth. designed like an elevator but cutting at the tip.
BT1-447 Luxator 3mm
BT1-448 Luxator 5mm



BT1-449
Explorer/Measuring Probe
The probe is used to measure gingival attachment loss and the depth of pockets around the tooth indicating periodontal disease. The probe is marked in mm increments 1-10mm.
Explorer/measuring probe



BT1-450
Very Fine Periosteal Elevator
Great for lifting the gum flap around cats' teeth and hard to reach areas. very fine periosteal elevator



BT1-451
Sickle Scaler
The scaler is used to remove plaque and calculus from the tooth surface. The sickle scaler tip can be used to remove calculus from the developmental grooves and blood grooves of canine teeth.
sickle scaler





BT1-452
 Jaquette Supraringival Scaler



BT1-459
 McCall Scaler, dual ended, 17cm



BT1-453
 Supraringival Curette



BT1-460
 Periosteal Elevator-Rougine



BT1-454
 Minnesota Retractor



BT1-461
 Mouth Mirror, Dual Ended



BT1-455
 Probe/explorer, Stainless



BT1-462
 Tartar Removing Forceps



BT1-456
 Tooth scaler for dog, right



BT1-457
 Tooth scaler for dog, left



BT1-463
 Extraction Forceps



BT1-458
 Tooth scaler for dog, dual ended



BT1-464
Root Tip Extraction Forceps.
6" /150 mm.



BT1-470
Universal Dental Forceps



BT1-465
Root fragment Extraction Forceps.
5 1/2" /138 mm.



BT1-471
Molt, Periosteal Elevator



BT1-466
Root Extractor



BT1-472
curved deciduous Elevator, small



BT1-467
Dental Forceps, straight



BT1-473
curved deciduous Elevator, medium



BT1-468
Dental Forceps, curved



BT1-474
curved deciduous Elevator, large



BT1-469
Dental Extractor S/S 11cm, for milk teeth



BT1-475
small breed/cat right angle extraction forceps

BT1-476
Elevator, 1mm, straight tip



BT1-477
Elevator, 2mm, straight tip



BT1-478
Probe Explorer



BT1-479
Periosteal Elevator, feline/small dogs



BT1-480
Resorptive Lesion probe feline/small dogs



BT1-481
Sickle scaler, feline/small dogs



BT1-482
Curette, feline/small dogs



BT1-483
Tooth Extractor, cats/small dogs



BT1-484
Feline 8 Piece Instrument Set



BT1-485
Surgical Extraction Set



BT1-486
Tooth Extractor Set With 14 Instruments



BT1-487
Tooth Extractor Set With 14 Instruments,
elevators with stubby handles



BT1-488
Specialized dental set with 5 instruments and tray



BT1-489
Offset Elevators
Angle Up, 16"



BT1-490
Offset Elevators
Angle Down, 16"



BT1-491
Offset Elevators
Angle Right, 16"



BT1-492
Offset Elevators
Angle Left, 16"



BT1-493
Offset Elevators
Set of Four, Up,
down, right, and
left angle, 16"



BT1-494
Elevators, Periosteal,
Molt, Del M9



BT1-495
U.S. Army Pattern Osteotomes,
6 1/2", 6mm

BT1-496
U.S. Army Pattern Osteotomes,
6 1/2", 12mm

BT1-497
U.S. Army Pattern Osteotomes,
6 1/2", 18mm

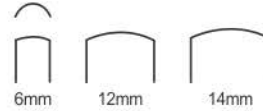

Equine Dental Gouge



BT1-498
Army Pattern Gouge
6 1/2", 12mm



BT1-499
Army Pattern Gouge
6 1/2", 14mm

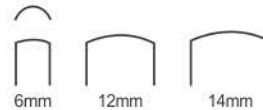

BT1-500
Army Pattern Gouge
6 1/2", 6mm



BT1-501
Army Pattern Gouge
6 1/2", 9mm, Curved



BT1-502
 Milk Sucking Preventor
 with Spring Made of
 Aluminium & Having
 2 Models with or
 without Spikes
 Size 4"



BT1-505
 French Style Milk Sucking
 Preventors Mini, Sml, Med, Lrg



BT1-503
 Plastic Milk Sucking Preventor
 With Different Colours With
 Different Sizes



BT1-506
 Spiked Swingarm Milk Sucking
 Preventors Made of Metal With
 Adjustment Nut
 Size 4"



BT1-504
 French Style Milk Sucking
 Preventors Mini, Sml, Med, Lrg



BT1-507
 French Style Milk Sucking
 Preventors



BT1-508
Stomach Pump
Size 12"



BT1-509
Stomach Pump
Size 12"



BT1-510
Balling Gun, Upto 6 Boluses
Can Be Administrated Per Animal,
Pistol Grip Handle



BT1-511
Balling Gun with Metal Head
with or without Spring
Size 60"



BT1-512
Balling Gun with Metal Head
with or without Spring
Size 18"



BT1-513
Balling Gun with Rubber
Head with or without spring
Size 18"



BT1-514
Balling Gun with Plastic
Head with or without spring
Size 18"



BT1-515
Balling Gun with Metal
Head with or without spring
Size 18"



BT1-516
Syringe



BT1-517
Syringe



BT1-518
Syringe with Plastic Handle



BT1-519
Revolver Syringe, Heavy Duty
Syringes with Metallic Body &
Glass Barrel Available in
10ml, 30ml, 50ml



BT1-520
Revolver Syringe, Heavy Duty
Syringes with Metallic Body &
Glass Barrel Available in
10ml, 30ml, 50ml



BT1-521
Syringe



BT1-522
Revolver Syringe
Cover Leather





BT1-523
Balling Gun With Spring Clip.
2 3/4" L, 1" dia. head.



BT1-524
Plastic Head With Spring Clip.
2 1/2" L, 7/8" dia. head.



BT1-525
Calf Balling Gun Clip.
1 1/2" L, 5/8" dia. head.



BT1-526
Adult Balling Gun.
Holds up to six full-size bolises. 7/8" dia.



BT1-527
Balling Gun.
Calf. 5/8" dia head. Blue. 13 1/2" L.

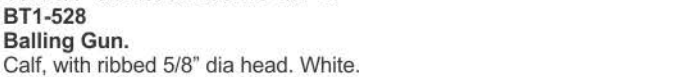

BT1-528
Balling Gun.
Calf, with ribbed 5/8" dia head. White.



BT1-529
Balling Gun.
Cow. 7/8" dia head. Red. 17 1/2" L.



BT1-530
Kant Suk Calf Weaner.



BT1-531
Lamb Nipple.
Red. 4/pk.



BT1-532
Hug's Teat Knife.
Blade 1/2". Stainless steel. 6"L.



BT1-533
Popular Danish Model Teat Knife,
with the short cutting and probe point. Stainless steel.



BT1-534
Christensen Teat Scissors,
with cutting edges on the outside of the blade; adjustable opening. 6"L.



BT1-535
Cornell Teat Curette. Stainless steel. 6"L.



BT1-536
Lichy Teat Knife. Blunt. Stainless steel. 5 1/2" L.



BT1-537
Lichy Teat Knife. Sharp. Stainless steel. 5 1/2"L.



BT1-538
Round Trocar.
Stainless steel with 10 plastic disposable cannulae. 5" shaft.



BT1-539
Oval Bloat Trocar with metal handle.



BT1-540
Round Metal Trocar
with wood handle. 5" metal portion
with 2 cannulas and one protective cap.

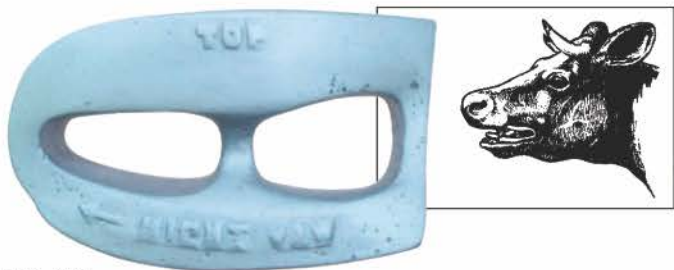

BT1-541
Drinkwater Mouth Gag
BT1-542
Mouth Gag, Right.
BT1-543
Mouth Gag, Left.



BT1-544
Frick's Standard Oral Speculum.
Heavy-duty. Stainless steel. 19 1/2".



BT1-545
JorVet Bovine Hobble Strap.

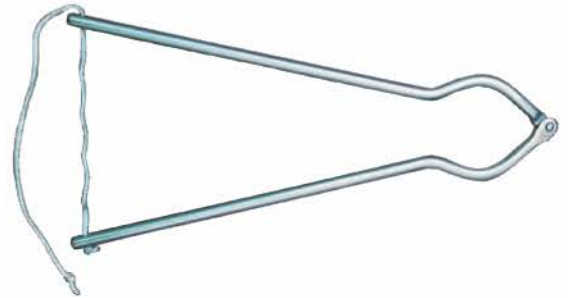

BT1-546
Equine Humane Twitch.
Stainless steel. 13"



BT1-547
Equine Chain Twitch.
chain twitch with plated chain. 5" dia. loop
with 25" flat wooden handle.



BT1-548
Polansky Vaginal Speculum.



BT1-549
Thoroughbred Vaginal Speculum.
with 2 blades. stainless steel. 28cm (11").



BT1-550
Killian Vaginal Speculum.
for dogs. has screw and 3 1/2"
blades. Stainless Steel.



BT1-551
 Anti Kick Clamp
 Size 18"



BT1-555
 Crook Head For Leg
 Size 5"



BT1-552
 Anti Kick Clamp
 Size 18"



BT1-556
 Sheep Cuff
 Size 5"



BT1-553
 Anti Kick Bar Spring
 For Anti Kick Bar
 Size 40"

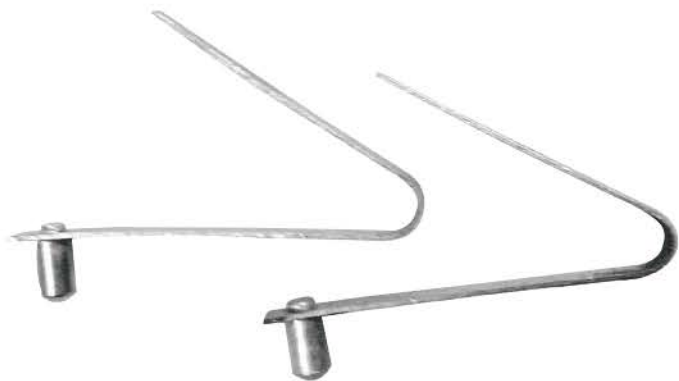

BT1-554
 Anti Kick Bar Spring
 For Anti Kick Bar



BT1-557
 shepherds Crook Neck Model
 135cm



BT1-558
 shepherds Crook Leg Model
 95cm



plane (nylon)
convex (steel)
plastic handle
Head 30mm Ø
Weight 675 Gr.

1/3

**MALLET
BT1-559**
26 cm, 10 1/2"



plastic handle
Head 42 / 30mm Ø
Weight 530 Gr.

1/3

**MALLET
BT1-560**
26 cm, 10 1/4"



plastic handle
Head 30mm Ø
Weight 480 Gr.

1/3

**MALLET
BT1-561**
24 cm, 9 1/2"



Plastic Handle
Head 30mm Ø
Weight 510 Gr.

1/3

**MALLET
BT1-562**
26 cm, 10 1/4"



Spare Facing (pair)
BT1-564
Plastic

disks and plastic handle
Head 37mm Ø
Weight 370 Gr.

1/3

**MALLET
BT1-563**
22.5 cm, 9"



made of plastic
Head 30mm Ø
Weight 125 Gr.

1/3

**MALLET
BT1-565**
18 cm, 7"



made of plastic
with lead filling
Head 42mm Ø
Weight 400 Gr.
Head 42mm Ø
Weight 250 Gr.

1/3

**MALLET
BT1-566**
26 cm, 10 1/4"



made of plastic
with lead filling
Head 42mm Ø
Weight 250 Gr.

1/3

**MALLET
BT1-567**
26 cm, 10 1/4"



BT1-568
Parker's Tenotome Knife.
Small, blunt and curved 15 x 3mm blade.



BT1-569
Tenotome Knife.
Blunt and curved 5cm x 1/2cm blade.



BT1-570
Tenotome Knife.
Blunt and straight 5cm x 1/2cm blade.



BT1-571
Tenotome Knife.
Sharp and curved 5cm x 1/2cm blade.



BT1-572
Tenotome Splitter.
Double edged blade.
Stainless steel. 4cm L blade.



BT1-573
Chamber's Equine Catheter. Stainless steel with slightly curved tip. finger rest, luer slip adaptor. The preferred instrument for flushing the guttural pouch. also can be used for uterine flushes. 8g. 22"L.

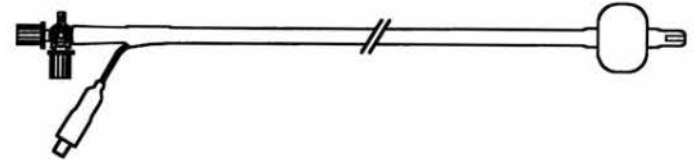

BT1-574
Broncho-Alveolar Lavage Catheter.

Equine Steinmann Pins



BT1-575
Steinmann Pin Single Trocar 15mm Threaded, 9" 2.0mm, 5/64" pkg 6

BT1-576
Steinmann Pin Single Trocar 15mm Threaded, 9" 2.4mm, 3/32" pkg 6

BT1-577
Steinmann Pin Single Trocar 15mm Threaded, 9" 2.8mm, 7/64" pkg 6

BT1-578
Steinmann Pin Single Trocar 15mm Threaded, 9" 2.0mm, 5/32" pkg 6

BT1-579
Steinmann Pin Single Trocar 25mm Threaded, 9" 2.4mm, 3/32" pkg 6

BT1-580
Steinmann Pin Single Trocar 25mm Threaded, 9" 2.8mm, 7/64" pkg 6

BT1-581
Steinmann Pin Chuck Key,
4" Cannulated Max, 5.0/7.0mm





Instruments Tray with recessed handle on lid. Cold sterilization.
BT1-582 Top: 10 1/4" x 6 3/4" x 2". Bottom: 9" x 5 1/2" x 2".
BT1-583 Top: 12 1/4" x 8" x 2". Bottom: 10 1/2" x 6 1/4" x 2".



Instruments Tray with strap handle on lid.
BT1-584 Top: 10 1/4" x 6 3/4" x 2". Bottom: 9" x 5 1/2" x 2".
BT1-585 Top: 12" x 8 1/4" x 2 1/4". Bottom: 10 1/2" x 6 1/4" x 2".



Mayo Tray.
BT1-586 Top: 13 3/4" x 10" x 2/3". Bottom: 11 3/4" x 7 1/2" x 2/3".
Instruments on Spay Pack Tray. Below trays without lids.
BT1-587 Top: 10 1/4" x 6 3/4" x 2". Bottom: 9" x 5 1/2" x 2".
BT1-588 Top: 12" x 7 3/4" x 1 15/16". Bottom: 10 1/2" x 6 1/4" x 2".



BT1-589
Stainless Steel Bucket. 13-quart all-purpose bucket with handle. Type 304. 10 1/4"H. Base-7 7/8" dia., top-11 1/2" dia.



BT1-590
Round Straight-Sided Pail. 12-quart stainless steel with handle. This pail takes up less storage space than conventional pails.



BT1-591
Catheter and Instrument Tray with cover and strap handle. 3"W x 8 2/3"L x 1 1/2"H. (22cm x ~7cm x 3.8cm.)

BT1-592
Catheter and Instrument Tray with cover. Top: 3 1/2"W x 12 1/2"L x 1 3/4"H. (32.4cm x 9.3cm x 4.4cm). Bottom: 12" x 3" x 1 3/4".

BT1-593
Catheter Tray. Top: 16" x 3" x 2 1/2". Bottom: 15 3/4" x 2 3/4" x 2".



BT1-594
Dressing Jar. 1-liter capacity. 5"H (10cm x 15.9cm) x 5" dia.

BT1-595
Dressing Jar. 2-liter capacity. 6 1/4" (12.7cm x 15.9cm) x 5" dia.



BT1-596
Thermometer Jar. Stores glass thermometers. Wide base to give greater stability and avoid jar from tipping over. 3 1/4"H (3.4cm x 9cm) x 1 1/3" dia.



BT1-597
Collin Speculum
Sizes: S, M, L



BT1-601
Sims Speculum
with fixing screw and cut



BT1-598
Speculum for she-lamb



BT1-599
Greaves Speculum
Sizes: S, M, L

BT1-600



BT1-602
Sims Speculum
with fixing screw and cut



BT1-600
CUSCO Speculum
Sizes: S, M, L

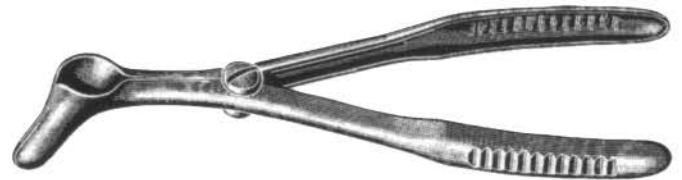

BT1-603
Vienna Speculum
For small animals

BT1-604

Galt Skull Trephine, with adjustable centering point and detachable cross-bar handle, 13mm

BT1-605

Galt Skull Trephine, with adjustable centering point and detachable cross-bar handle, 19mm

BT1-606

Galt Skull Trephine, with adjustable centering point and detachable cross-bar handle, 25mm



BT1-607

2 Inch Trephine



BT1-608

Trephine Set with 3 attachments

BT1-609

Necropsy Knife. wide blade. 5"



BT1-610

Necropsy Knife. narrow blade. 5"



BT1-611

Curved Boning Knife. 6"



BT1-612

Necropsy Knife. Curved. 6"



BT1-613

Steel Sharpener.



BT1-616

BIRDTEK
MANUFACTURING CORPORATION



BT1-614

Diamond Sharpener. Medium. Comes with leather case.



BT1-615

Postmortem Scissors. Heavy-duty scissors with one serrated edge and black finished rings. 2" cutting blade. 7 3/4"L.



BT1-616

Rib Shear. Cuts through rib case on small animals and younger large animals. German-made. stainless steel. 9" length.

Mouth Gags



BT1-617
Equine full Speculum including leather strap superior quality



BT1-619
Schulze Mouth Gags with wooden handle.



BT1-620
Schoupe Mouth Gags



BT1-618
Mouth Plates



Large

BT1-622
Mouth Gags for Small Animals



Medium



Small



BT1-621
Guenther's Mouth Gags
inside width 17.5cm
inside length 11cm.



Extra Small



BT1-623
Equestrian Equipments



BT1-624
Mouth Speculum
with leather straps



BT1-625
Mouth Speculum Haussmann
Model with Leather Straps,
or Nylon Straps

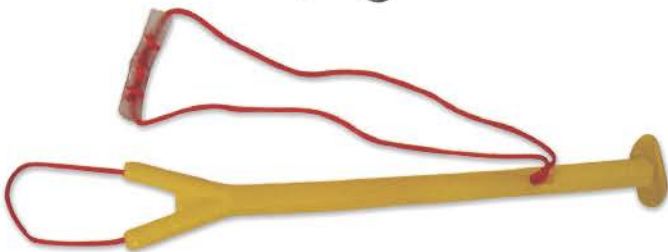

BT1-626
Lambing Aid Plastic
Small plastic snare with y configured head

Marking Instruments

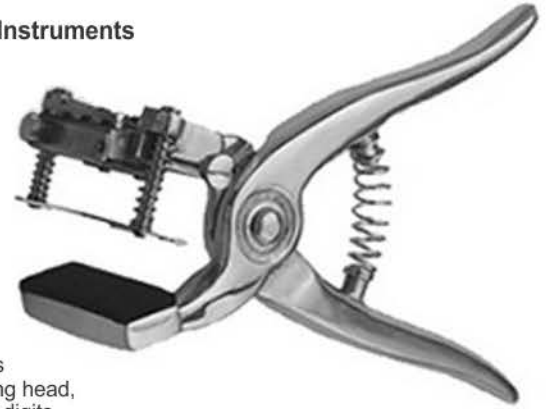

BT1-627
Tattoo Pliers
with revolving head,
for 3/8" four digits.



BT1-628
Tattoo Pliers
Standard,
for 3/8" four digits.



BT1-629
Tattoo Pliers



BT1-630
Tattoo Pliers Digits.
3/8" digits (0-9 & A-Z)

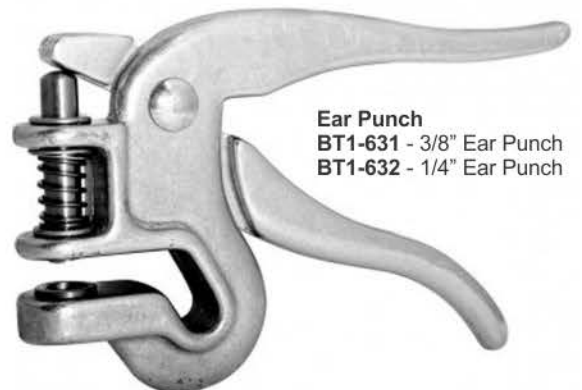

Ear Punch
BT1-631 - 3/8" Ear Punch
BT1-632 - 1/4" Ear Punch

BT1-633 Snake Tong
17" (182.5cm) constructed of blue top quality aluminum



BT1-634 Standard Snake Tong
52" Standard Snake Tong



BT1-635 Snake Tong
24"



BT1-636 Professional Reptile Snake Tong
25" Stainless Steel Wire.



BT1-637 Reptile Snake Tong
52" from handle to jaw
Stainless Steel Cable.



BT1-638 Snake Catcher
90" & 110"
Stainless Steel.



BT1-639 Gentle Giant Collapsible Snake Tong
52", 40", 52", 60", 72".



BT1-640 Gentle Snake Tong Gentle jaws made with fine aluminum
25", 40", 52", 60", 72".



BT1-641 Snake Tong Strong Shaft To Handle Big Reptiles with fine aluminum
25", 40", 52", 60", 72".



BT1-642 Snake Tong Strong Shaft To Handle Big Reptiles with fine aluminum
25", 40", 52", 60", 72".



BT1-639

BT1-643 Snake Tong Strong Shaft To Handle Big Reptiles with fine aluminum
25", 40", 52", 60", 72".



BT1-644 Snake Tong Strong Shaft To Handle Big Reptiles with fine aluminum
25", 40", 52", 60", 72".



BT1-645 Snake Tong
The jaw and handle of this tong is made from best quality aluminum with nice grip.
25", 40", 52", 60", 72".





BT1-646 Snake Tong
The jaw and handle of this tong is made from best quality aluminum with nice grip. 25", 40", 52", 60", 72".



BT1-647 Snake Tong
The jaw and handle of this tong is made from best quality aluminum with nice grip. 25", 40", 52", 60", 72".

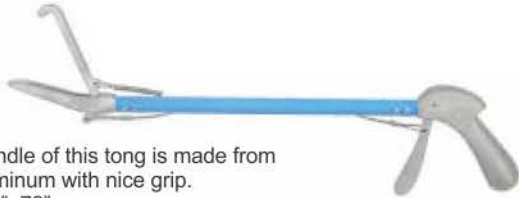

BT1-648 Snake Tong
The jaw and handle of this tong is made from best quality aluminum with nice grip. 25", 40", 52", 60", 72".



BT1-649 Snake Hook
traditional snake hook stainless steel material. 100cm, 39.99".



BT1-650 Professional Snake Hook
45".



BT1-651 Standard Snake Hook
Stainless Steel 45".



BT1-652 Mini Snake Hook
for small snakes 24"



BT1-653 Ideal Snake Hook
18"



BT1-654 Snake Hook
16", 24", 38", 45", 48", 55".



BT1-655 Snake Hook
This hook is made out of best quality stainless steel. Solid rod with rubber coated tip and nice aluminum handle. 16", 24", 38", 45", 48", 55".



BT1-656 Snake Hook
This pinning hook is made out of best quality steel with nice rubber handle for nice grip. 16", 24", 38", 45", 48", 55".

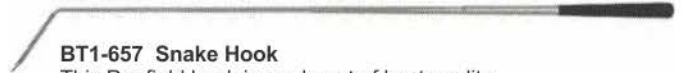

BT1-657 Snake Hook
This Pro field hook is made out of best quality steel with nice rubber handle for better grip. 16", 24", 38", 45", 48", 55".



BT1-658 Snake Hook
16", 24", 38", 45", 48", 55".



BT1-659 Snake Hook 18" Tight mouth hook
16", 18", 24", 38", 45", 48", 55".



BT1-660 Snake Hook
This hook is made out of best quality stainless steel. Solid rod with rubber coated tip and nice aluminum handle. 16", 24", 38", 45", 48", 55".

BT1-661

CANINE SPAY SET

- A #3 Knife Handle
- B Mayo Scissors Straight 6-3/4"
- C Metzenbaum Scissors 7" Curved
- D Tissue Forceps 5-1/2", 1x2 Teeth
- E Brown Adson Forceps 4 3/4", 7x7 Teeth
- F Halsted Mosquito Forceps 5" Curved
- G Kelly Forceps 5-1/2" Curved
- H Roch-Carmalt Forceps 6-1/4" Cvd. + Str.
- I Backhaus Towel Clamp 3-1/2"
- J TC Olsen Hegar Needle Holder 6-1/2" TC
- K Allis Tissue Fcp 4x5 Teeth 6"
- L Snook Ovariectomy Hook

BT1-662

FELINE SPAY SET

- A #3 Knife Handle
- B Mayo Scissors Straight 6-3/4"
- C Metzenbaum Scissors 7" Curved
- D Tissue Forceps 5-1/2", 1x2 Teeth
- E Brown Adson Forceps 4 3/4", 7x7 Teeth
- F Halsted Mosquito Forceps 5" Curved
- G Kelly Forceps 5-1/2" Curved
- H Roch-Carmalt Forceps 6-1/4" Curved
- I Backhaus Towel Clamp 3-1/2"
- J TC Olsen Hegar Needle Holder 5-1/2" TC
- K Allis Tissue Fcp 4x5 Teeth 6"
- L Snook Ovariectomy Hook

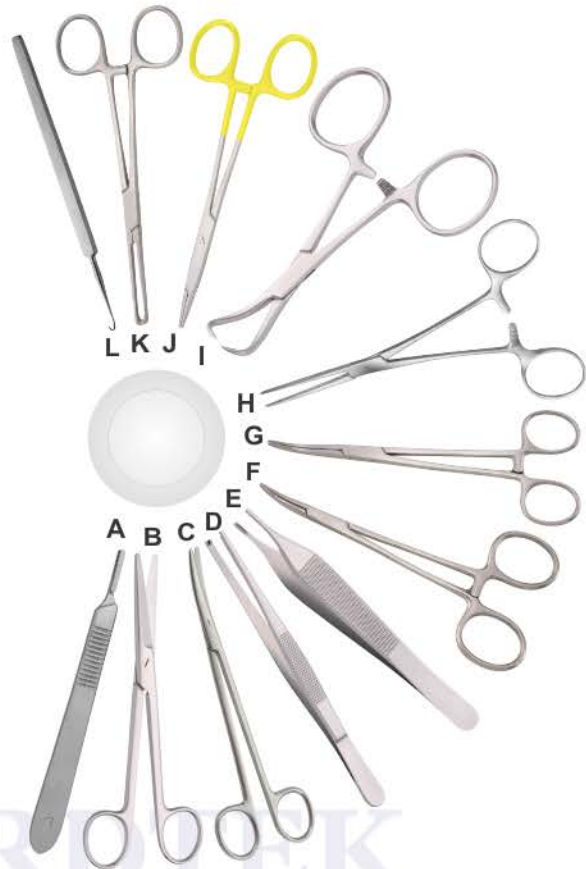

BIRDTEK
MANUFACTURING CORPORATION

BT1-663

GENERAL SURGERY SET

- A #3 Knife Handle
- B Mayo Scissors Straight 6-3/4"
- C Metzenbaum Scissors 7" Curved
- D Tissue Forceps 5-1/2", 1x2 Teeth
- E Brown Adson Forceps 4 3/4", 7x7 Teeth
- F Halsted Mosquito Forceps 5" Curved
- G Kelly Forceps 5-1/2" Curved
- H Roch-Carmalt Forceps 6-1/4" Curved
- I Backhaus Towel Clamp 3-1/2"
- J TC Olsen Hegar Needle Holder 5-1/2" TC
- K Snook Ovariectomy Hook
- L Allis Tissue Forceps 6", 5 X 6 Teeth
- M Sen Retractor
- N Suture Scissors, 8", sharp-Blunt

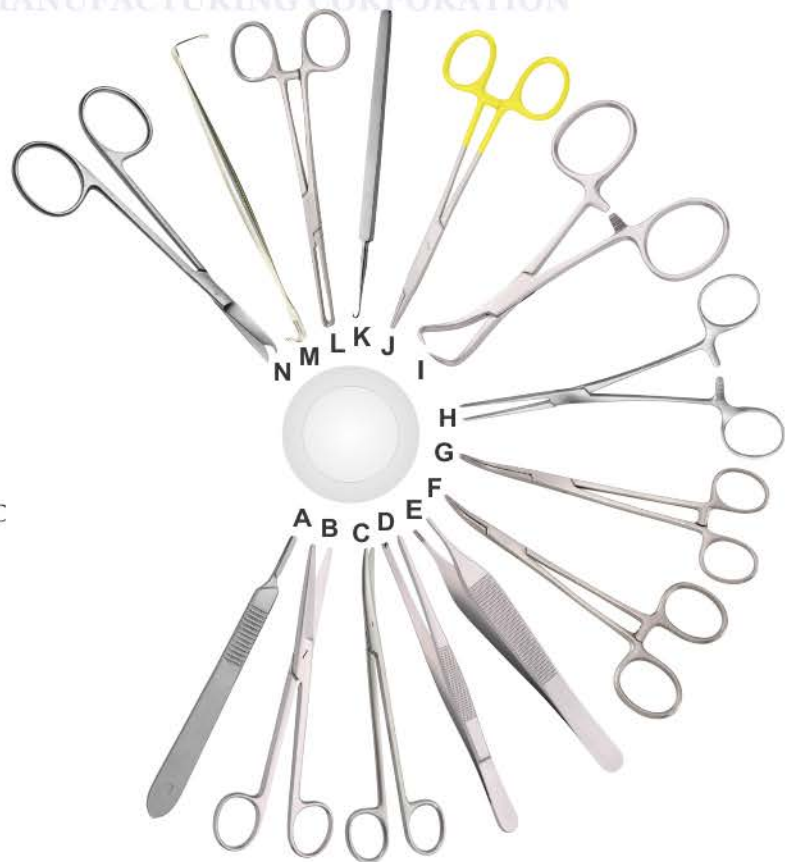

BT1-664

CASTRATION EMASCULATORS INSTRUMENTS

- A WHITE Emasculator 12"
- B PLAIN Emasculator 12"
- C FRANK Emasculator 9"
- D Small WHITE Emasculator

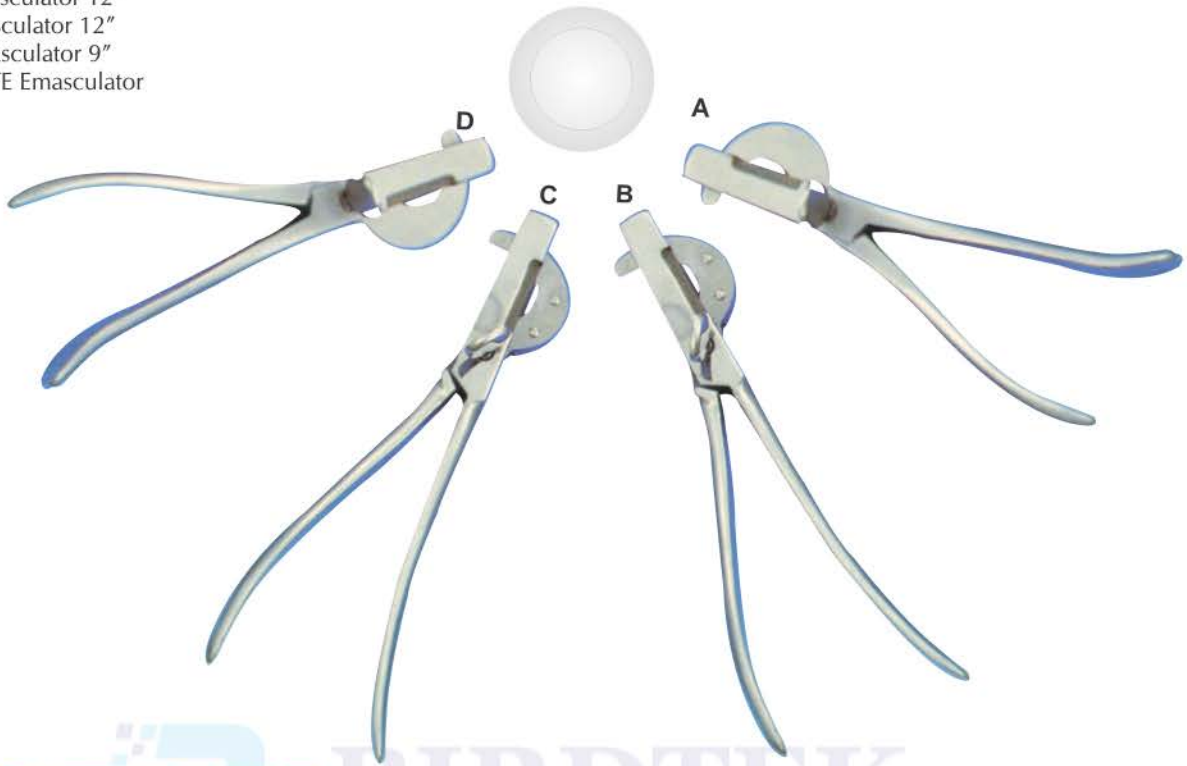

BT1-665

STANDARD VETERINARY EYE SET

- A #3 Scalpel Handle
- B Wire Eye Speculum
- C Eye Dressing Forceps 4"
- D Chalzion Forceps
- E Stevens Tenotomy Scissors 4-1/8"
- F Castroviejo Needle Holder 5-1/2" Str.
- G Bishop-harman, Toothed Forceps
- H Baby Olsen-hegar N/Holder Tc Tip
- I Desmarres Retractor



**BT1-666
STANDARD VETERINARY ORTHOPEDIC INSTRUMENT SET**

- A Wire Cutter
- B Senn Retractor Blunt 6 3/8" (16.2cm), blunt prongs, double end
- C Senn Retractor Sharp 6 3/8" (16.2cm), sharp prongs, double end
- D Weitlaner Retractor 5 1/4" (13cm)
- E Freer Elevator 7" (17.8cm) double end, sharp and blunt blades
- F Bone Curette
- G Mallet
- H Bone File
- I Wire twister 6" (15.2) with Carb-N-Sert jaws
- J Kern Bone Holding Forceps Small 6 1/2" (15.2cm), with ratchet
- K Kern Bone Holding Forceps Large 9 1/2" (24.1cm), with ratchet
- L Bone Cutting Forceps
- M Pin Cutter
- N Osteotome



BT1-667

SPAYING & TEAT INSTRUMENTS

- A COVAULT Ovariectomy Hook with probe tip, 8-1/4"
- B SNOOK Ovariectomy Hook, 8"
- C SNOOK Ovariectomy Hook, 8"
- D UDALL Teat Bistouri, 6-1/4", blunt
- E LICHTY Teat Knife, 5-1/2", sharp point
- F LICHTY Teat Knife, 5-1/2", blunt end
- G CORNELL Teat Curette, 6-1/4"
- H BOWER Obstetrical Forceps, 9-1/2", Straight, serrated jaws
- I BOWER Obstetrical Forceps, 9-1/2", curved, serrated jaws



BT1-668

CANINE PERIODONTAL SET

- A Mirror Handle Cone Socket
- B Mirror #4
- C Explorer 2
- D Probe 20-23 Explorer
- E Curette Columbia 13-14 Fine
- F Curette Columbia 4L-4R
- G Snook Ovariectomy Hook



BIRDTEK
MANUFACTURING CORPORATION

BT1-669

GROOMING INSTRUMENTS

- A White Toenail Scissors 4-1/2"
- B Tissue & Cuticle Nipper 4" Convex Jaws
- C Tissue & Cuticle Nipper 4-1/2" Convex Jaws
- D Tissue & Cuticle Nipper 5" Convex Jaws
- E Tissue & Cuticle Nipper 5" Convex Hvy Pattern
- F Fetlock Clipper
- G Set of 2 Blades for Fetlock Clipper
- H Wing Nut for Fetlock Clipper

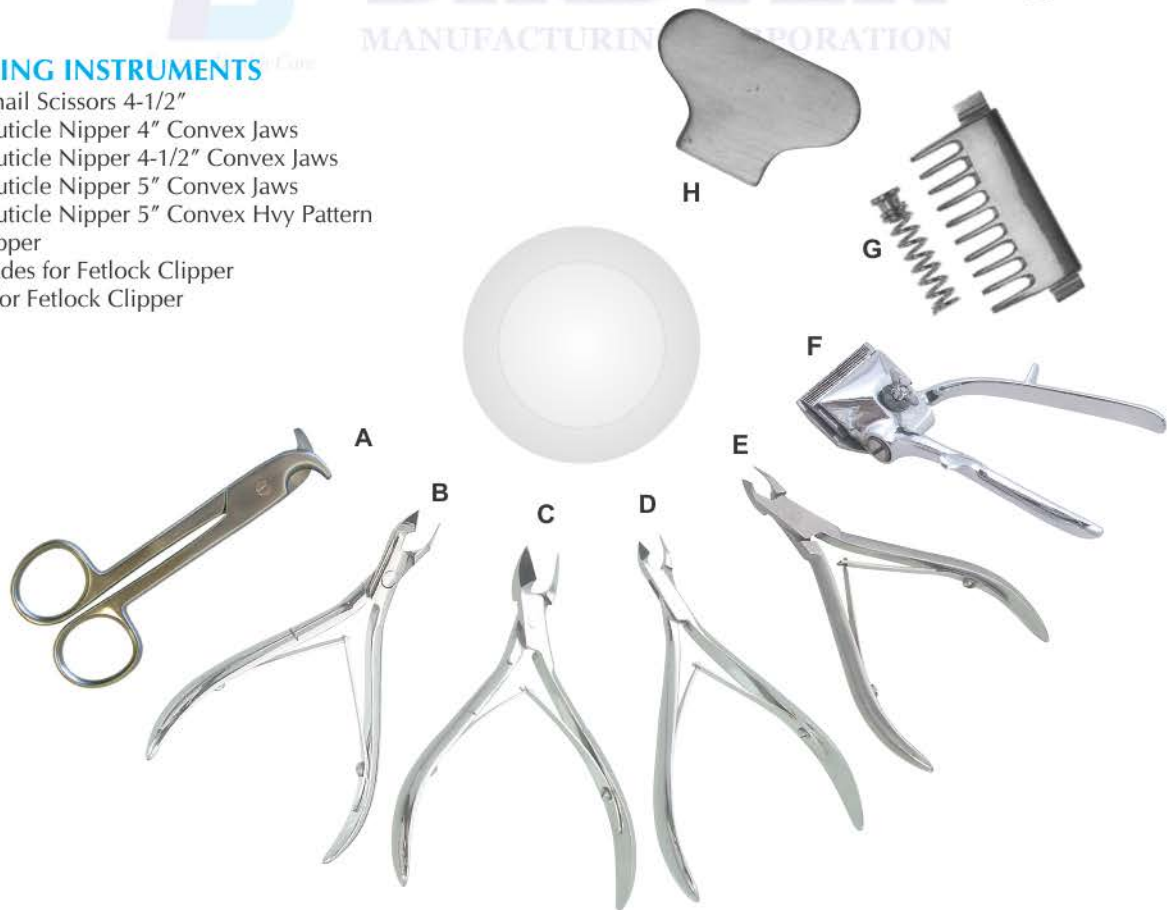

BT1-670

CANINE & FELINE TARTAR SCRAPERS

- A Canine & Feline Tartar Scrapers Claw Type
- B Canine & Feline Tartar Scrapers Curved w Straight Edge
- C Canine & Feline Tartar Scrapers Angular, Pointed
- D Canine & Feline Tartar Scrapers Triangular
- E Canine & Feline Tartar Scrapers Curved w Angled Edge
- F Canine & Feline Tartar Scraper DE, Cvd w Angled Edges
- G Universal Scaler #12 - Double Ended, Solid
- H Towner Scaler #15 - Single Ended, Solid
- I Towner Scaler #15/33 - Double Ended, Solid
- J Universal Scaler #3 - Single Ended, Solid
- K Universal Scaler #33 - Single Ended, Solid
- L Universal Scaler #34 - Single Ended, Solid
- M Tartar Remover 4.5" Small
- N Tartar Remover 5.5" - Large

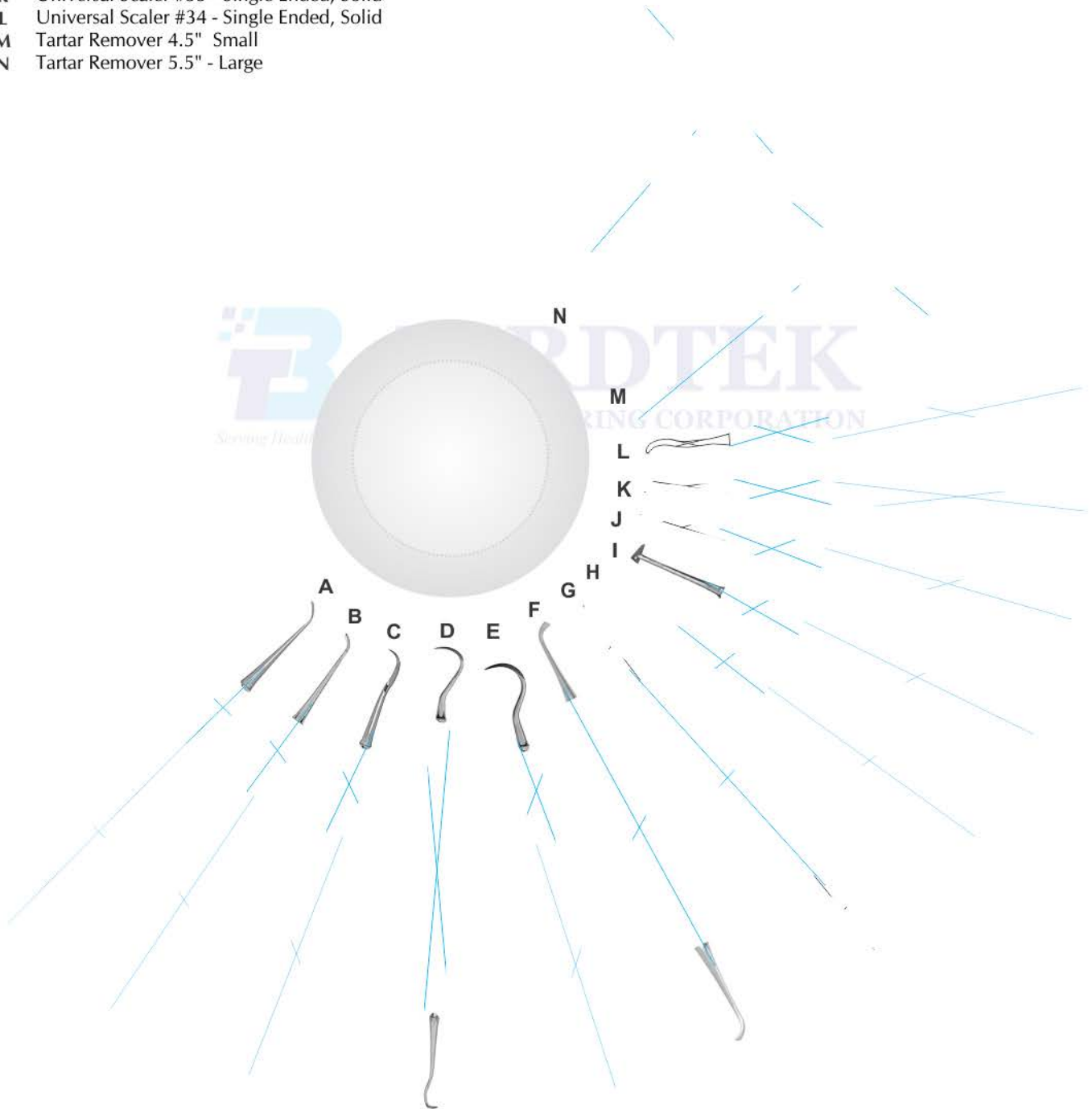

BT1-671

RESTRAINT INSTRUMENTS

- A Petite Mouth Gag 2-1/4" Lightweight
- B Feline Mouth Gag 3" Lightweight
- C Canine Mouth Gag 4" Small Size
- D Canine Mouth Gag 4" Medium Size
- E Canine Mouth Gag 6-3/4" Large Size

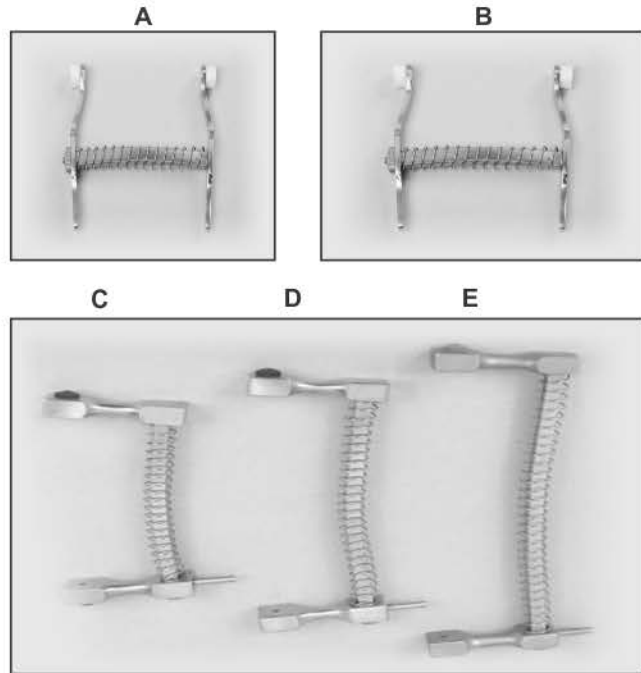

BT1-672

VETERINARY PERIODONTAL BASIC KIT -MEDICAN

- A Mirror Handle Complete
- B Probe/Explorer CP 12/23
- C Tower-Jaquette Scaler
- D Gracey Anterior Curette
- E Gracey Posterior Curette
- F Columbia Curette
- G Large Surgical Elevator
- H Small Surgical Elevator
- I Extra Surgical Elevator



CURETTES, SCALERS & PROBES



BT1-673 Jacquette Scaler #1S/1S (33/33) Solid



BT1-674 Jacquette Scaler #2S/3S (34/35) - Solid



BT1-675 Jacquette Scaler #2/3 (31/32) - Solid



BT1-676 Gracey Curette #11/12 - Solid



BT1-677 Gracey Curette #13/14 - Solid



BT1-678 Columbia Curette #13/14 - Solid Handle

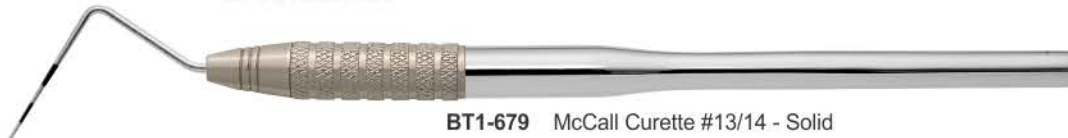

BT1-679 McCall Curette #13/14 - Solid



BT1-680 Goldman-Fox Probe - Flat, Single Ended



BT1-681 Expro #23/Williams

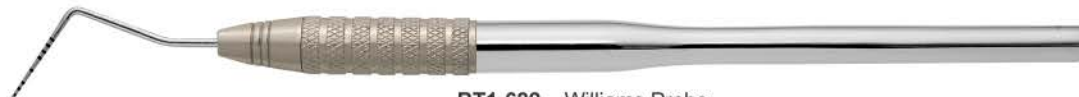

BT1-682 Williams Probe



BT1-683 Williams/Fox Probe - Double Ended



BT1-684 Holmstrom Plugger/Spreader #90 - 45mm

BT1-685

SPECULA

- A VIENNA Nasal Speculum, 5-3/4" (14.6cm), standard pattern, 1-1/8" (2.8cm) blades
- B VIENNA Nasal Speculum, 5-3/4" (14.6cm), standard pattern, 1-1/8" (2.8cm) blades (Vantage Brand)
- C VIENNA Nasal Speculum, 5-3/4" (14.6cm), light pattern, 1-1/8" (2.8cm) blades
- D KILLIAN Speculum, 6" (15.2cm), with set screw, 3-1/2" (8.9cm) blades
- E GRAVES Vaginal Speculum, 3-3/4" (14.6cm), small
- F GRAVES Vaginal Speculum, 3-3/4" (14.6cm), small (Vantage Brand)



BT1-686

ABDOMINAL PACK SET

- A Balfour Retractor
- B Baby Balfour Retractor
- C Central Blade Only
- D De Bakey Forceps
- E Doyen Intestinal Clamps
- F Metzenbaum Scissor 18cm
- G T/c Olsen Hegar Needle Holder 18cm
- H Poole Suction Tube.

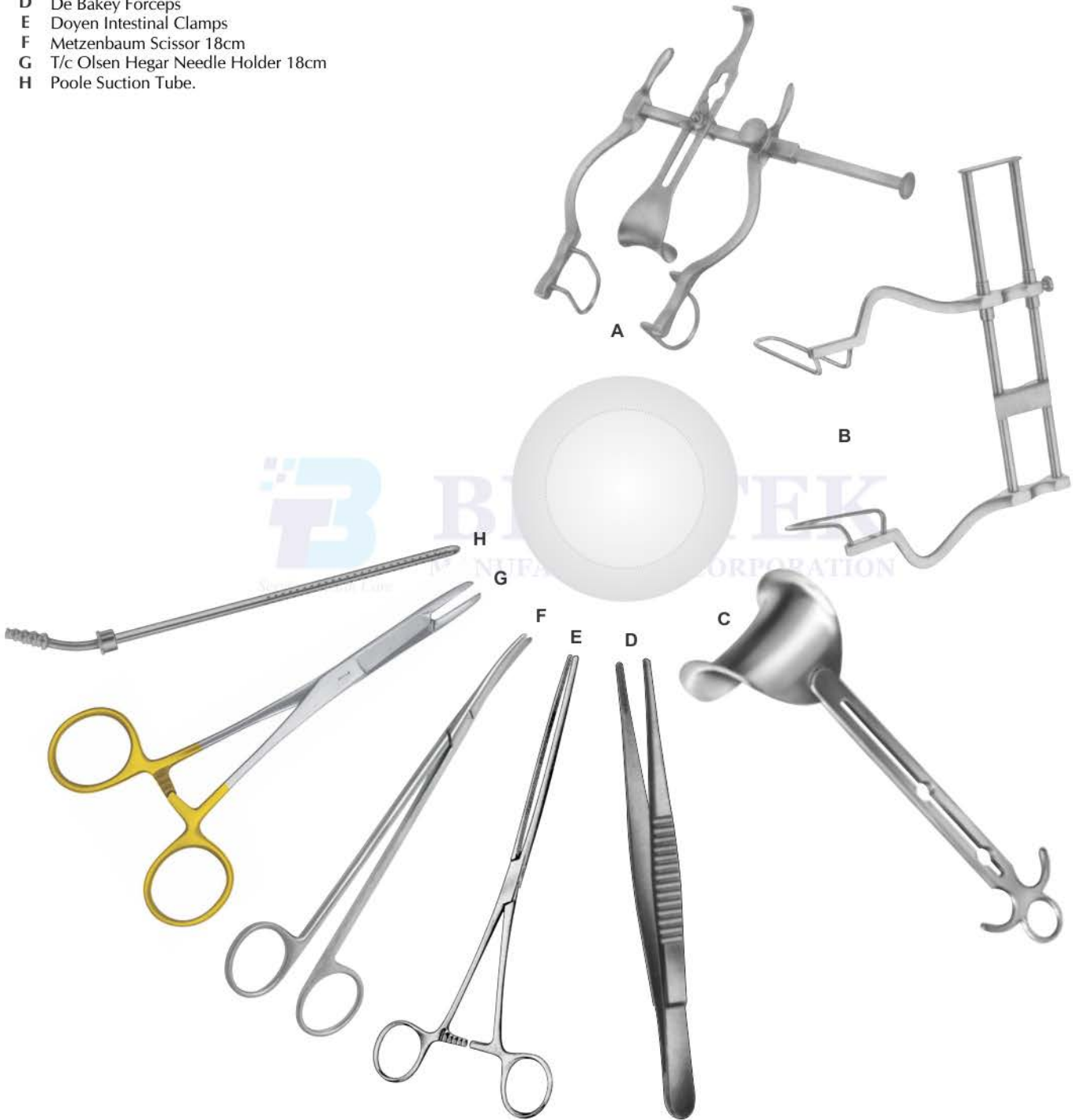

BT1-687

DENTAL PACK SET

- A Winged Elevators
- B Dental Extracting Forceps
- C Root Elevator 76N
- D Explorer D/E
- E Curettes Columbia 13-14
- F Curettes Columbia 4L-4R
- G Scaler, Jacquette 2S-3S
- H Periosteal Elevator
- I T/c N/Holder



BT1-688

NEUTER PACK SET

- A Halstead Mosquito 12cm
- B Crile Wood N/holder Tc
- C Allis Tissue Forceps
- D Backhaus Towel Clips
- E Olsen-Hegar N/Holder
- F Metzenbaum Scissors
- G Adson Tissue Forceps
- H Scalpel Handle No.3 with scale



BT1-689

CRUCIATE PACK SET

- A Baby Gelpi
- B Martin Cartilage Forceps
- C Deschamps Needle right small or large
- D Smilie Menisectomy Knife
- E Mini-Hohlmann
- F Hohmann Retractor



BT1-690
RODENT PACK SET

- A Mouth Gag
- B Check Retractors
- C Tooth Cutter
- D Tooth Extracting Forceps
- E Spatula
- F Molar Luxator 3mm
- G Incisor Luxator 5mm
- H Curettes



BT1-691

VETERINARY EXTRACTION BASIC SET-

- A** #3 Scalpel Handle
- B** Baby molt Periosteal Elevator
- C** Extracting Forceps
- D** Universal, mini, La Grange Scissors 4 1/4"
- E** Olsen-Hegar Needle Holder Combined suture scissors 5 1/2"
- F** Brown- Adson Tissue Forceps, 4 3/4"
- G** Operating Scissors Straight 5 1/2"
- H** Luxating Elevator Straight & Curved 2mm
- I** Luxating Elevator Straight & Curved 3mm
- J** Luxating Elevator Straight & Curved 5mm





Operating Scissors
BT1-692
 16.5cm 6 1/2"



Neurosurgical Scissors
 Strully
BT1-697
 22.5cm 8 3/4"



Operating Scissors
BT1-693
 20.5cm 8"



Enterotomy Scissors
BT1-698
 21.5cm 8 1/2"



Operating Scissors
BT1-694
 14.5cm 5 3/4"



Stitch Scissors
 Spencer
BT1-699
 9cm 3 1/2"

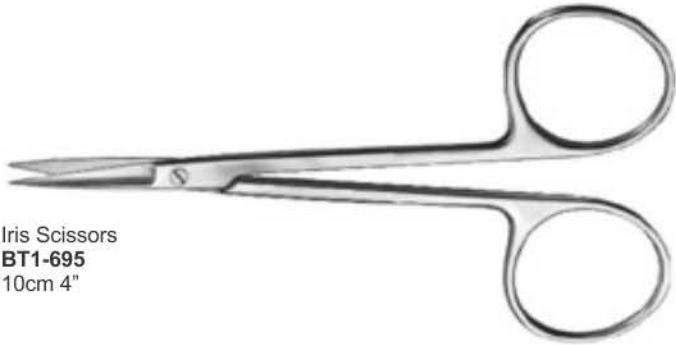

Iris Scissors
BT1-695
 10cm 4"



Stitch Scissors
 Spencer
BT1-700
 13cm 5"



BT1-696
 Lexer-Baby
 10cm 10 1/4"



Vascular Scissors
BT1-701
 12cm 4 3/4"

Pet Grooming Cutting Scissor

BT1-702
Left Handed 8" Straight
Pet Grooming Scissor / Shear

BT1-703
Left Handed 8" Curved
Pet Grooming Scissor / Shear

BT1-704
Left Handed 7.5" Straight
Pet Grooming Scissor / Shear

BT1-705
Left Handed 7.5" Curved
Pet Grooming Scissor / Shear

BT1-706
Pet Grooming Scissors, 6" Straight
Professional Stainless Steel Scissors

BT1-707
Pet Grooming Scissors, 6" Curved
Professional Stainless Steel Scissors

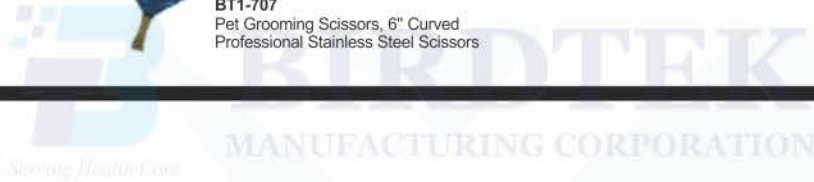

Pet Grooming Cutting Scissor

BT1-708
6" Straight
Pet Grooming
Scissor / Shear

BT1-709
6" Curved
Pet Grooming
Scissor / Shear

BT1-710
7.5" Straight
Pet Grooming
Scissor / Shear

BT1-711
7.5" Curved
Pet Grooming
Scissor / Shear

BT1-712
Pet Grooming
Scissors, 8" Straight
Professional
Stainless Steel Scissors

BT1-713
Pet Grooming
Scissors, 8" Curved
Professional
Stainless Steel Scissors





BT1-714
8" Straight
Pet Grooming
Scissor / Shear

BT1-715
8" Curved
Pet Grooming
Scissor / Shear

BT1-716
7.5" Straight
Pet Grooming
Scissor / Shear

BT1-717
7.5" Curved
Pet Grooming
Scissor / Shear

BT1-718
6" Straight
Pet Grooming
Scissor / Shear

BT1-719
6" Curved
Pet Grooming
Scissor / Shear

Pet Grooming Cutting Scissor



BT1-720
6" Straight
Pet Grooming
Scissor / Shear

BT1-721
6" Curved
Pet Grooming
Scissor / Shear

BT1-722
6" Straight
Pet Grooming
Scissor / Shear

BT1-723
6" Curved
Pet Grooming
Scissor / Shear

Pet Grooming Cutting Scissor



Pet Grooming Cutting Scissor

BT1-724
8" Curved
Pet Grooming
Scissor / Shear

BT1-725
8" Curved
Pet Grooming
Scissor / Shear



BT1-726
7.5" Straight
Pet Grooming
Scissor / Shear

BT1-727
7.5" Curved
Pet Grooming
Scissor / Shear



Serving Health Care

BIRDTEK
MANUFACTURING CORPORATION

Pet Grooming Cutting Scissor

BT1-728
7.5" Straight
Pet Grooming
Scissor / Shear

BT1-729
7.5" Curved
Pet Grooming
Scissor / Shear



BT1-730
8" Straight
Pet Grooming
Scissor / Shear

BT1-731
8" Curved
Pet Grooming
Scissor / Shear



Pet Grooming Cutting Scissor

BT1-732
8" Straight
Pet Grooming
Scissor / Shear

BT1-733
8" Curved
Pet Grooming
Scissor / Shear



BT1-734
6" Straight
Pet Grooming
Scissor / Shear

BT1-735
6" Curved
Pet Grooming
Scissor / Shear



Serving Health Care

BIRDTEK
MANUFACTURING CORPORATION

Pet Grooming Cutting Scissor

BT1-736
8" Straight
Pet Grooming
Scissor/ Shear

BT1-737
8" Curved
Pet Grooming
Scissor/ Shear



BT1-738
7.5" Straight
Pet Grooming
Scissor/ Shear

BT1-739
7.5" Curved
Pet Grooming
Scissor/ Shear

BT1-740
6" Straight
Pet Grooming
Scissor/ Shear

BT1-741
6" Curved
Pet Grooming
Scissor/ Shear



Pet Grooming Cutting Scissor

BT1-742
 8" Straight
 Pet Grooming
 Scissor / Shear

BT1-743
 8" Curved
 Pet Grooming
 Scissor / Shear



Pet Grooming Cutting Scissor

BT1-744
 7.5" Straight
 Pet Grooming
 Scissor / Shear

BT1-745
 7.5" Curved
 Pet Grooming
 Scissor / Shear



BT1-746
 7.5" Straight
 Pet Grooming
 Scissor / Shear

BT1-747
 7.5" Curved
 Pet Grooming
 Scissor / Shear



BT1-748
6" Straight
Pet Grooming
Scissor / Shear

BT1-749
6" Curved
Pet Grooming
Scissor / Shear

Pet Grooming Cutting Scissor



BIRDTEK
MANUFACTURING CORPORATION



BT1-750
7.5" Straight
Pet Grooming
Scissor / Shear

BT1-751
7.5" Curved
Pet Grooming
Scissor / Shear

Pet Grooming Cutting Scissor



BT1-752
Left Handed 8" Straight
Pet Grooming Scissor / Shear

BT1-753
Left Handed 8" Curved
Pet Grooming Scissor / Shear



BT1-754
Left Handed 7.5" Straight
Pet Grooming Scissor / Shear

BT1-755
Left Handed 7.5" Curved
Pet Grooming Scissor / Shear



BT1-756
8.5" Straight
Pet Grooming Scissor / Shear

BT1-757
8.5" Curved
Pet Grooming Scissor / Shear



BT1-758
Pet Grooming Scissors, 6" Straight
Professional Stainless Steel Scissors

BT1-759
Pet Grooming Scissors, 6" Curved
Professional Stainless Steel Scissors



Razor Shear
BT1-760
Size 5.5" Straight
Paper Coated

Razor Shear
BT1-761
Size 5.5" Curved
Paper Coated



Razor Shear
BT1-762
Size 5.5" Straight
Paper Coated

Razor Shear
BT1-763
Size 5.5" Curved
Paper Coated



Razor Shear
BT1-764
Size 5.5" Straight
Paper Coated

Razor Shear
BT1-765
Size 5.5" Curved
Paper Coated



Razor Shear
BT1-766
Size 5.5" Straight
Paper Coated

Razor Shear
BT1-767
Size 5.5" Curved
Paper Coated



Razor Shear
BT1-768
Size 5.5" Straight
Paper Coated

Razor Shear
BT1-769
Size 5.5" Curved
Paper Coated





Thinning Scissors
BT1-770 6" Straight
(8 Teeth)

Thinning Scissors
BT1-771 6" Curved
(8 Teeth)



Thinning Scissors
BT1-778 6" Straight
BT1-779 6.5" Straight
BT1-780 7" Straight
(19 Teeth)

Thinning Scissors
BT1-781 6" Curved
BT1-782 6.5" Curved
BT1-783 7" Curved
(19 Teeth)



Thinning Scissors
BT1-772 6" Straight
(11 Teeth)

Thinning Scissors
BT1-773 6" Curved
(11 Teeth)



Thinning Scissors
BT1-784 6" Straight
(22 Teeth)

Thinning Scissors
BT1-785 6" Curved
(22 Teeth)



Thinning Scissors
BT1-774 6" Straight
(13 Teeth)

Thinning Scissors
BT1-775 6" Curved
(13 Teeth)



Thinning Scissors
BT1-786 6" Straight
(23 Teeth)

Thinning Scissors
BT1-787 6" Curved
(23 Teeth)



Thinning Scissors
BT1-776 6" Straight
(13 Teeth)

Thinning Scissors
BT1-777 6" Curved
(13 Teeth)



Thinning Scissors
BT1-788 6" Straight
(24 Teeth)

Thinning Scissors
BT1-789 6" Curved
(24 Teeth)





Thinning Scissors
BT1-790 6.5" Straight
BT1-791 7" Straight
Thinning Scissors
BT1-792 6.5" Curved
BT1-793 7" Curved



Thinning Scissors
BT1-794 6.5" Straight
BT1-795 7" Straight
Wire Cut
Thinning Scissors
BT1-796 6.5" Curved
BT1-797 7" Curved
Wire Cut



Thinning Scissors
BT1-798 6.5" Straight
BT1-799 7" Straight
Texture
Thinning Scissors
BT1-800 6.5" Curved
BT1-801 7" Curved
Texture



Thinning Scissors
BT1-802 6.5" Straight
BT1-803 7" Straight
Thinning Scissors
BT1-804 6.5" Curved
BT1-805 7" Curved



Thinning Scissors
BT1-806 6.5" Straight
BT1-807 7" Straight
Regular
Thinning Scissors
BT1-808 6.5" Curved
BT1-809 7" Curved
Regular



Thinning Scissors
BT1-810 6" Straight
Wire cut
Thinning Scissors
BT1-811 6" Curved
Wire cut



Thinning Scissors
BT1-812 6" Straight
Wire cut
Thinning Scissors
BT1-813 6" Curved
Wire cut



Thinning Scissors
BT1-814 6" Straight
Texture
Thinning Scissors
BT1-815 6" Curved
Texture



Thinning Scissors
BT1-816 6" Straight
Texture
Thinning Scissors
BT1-817 6" Curved
Texture



Thinning Scissors
BT1-818 6" Straight
Texture
Thinning Scissors
BT1-819 6" Curved
Texture



Stripping Knife



Stripping Knife



Stripping Knife



Stripping Knife





Stripping Knife



Stripping Knife





Stripping Knife



Stripping Knife





Stripping Knife

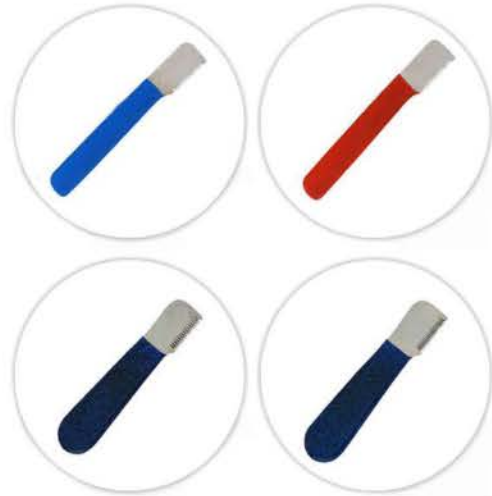

BIRDTEK
MANUFACTURING CORPORATION
Serving Health Care



Stripping Knife





Stripping Knife



Stripping Knife



Stripping Knife



Stripping Knife





PET COMB



BIRDTEK
MANUFACTURING CORPORATION
Serving Health Care



PET COMB



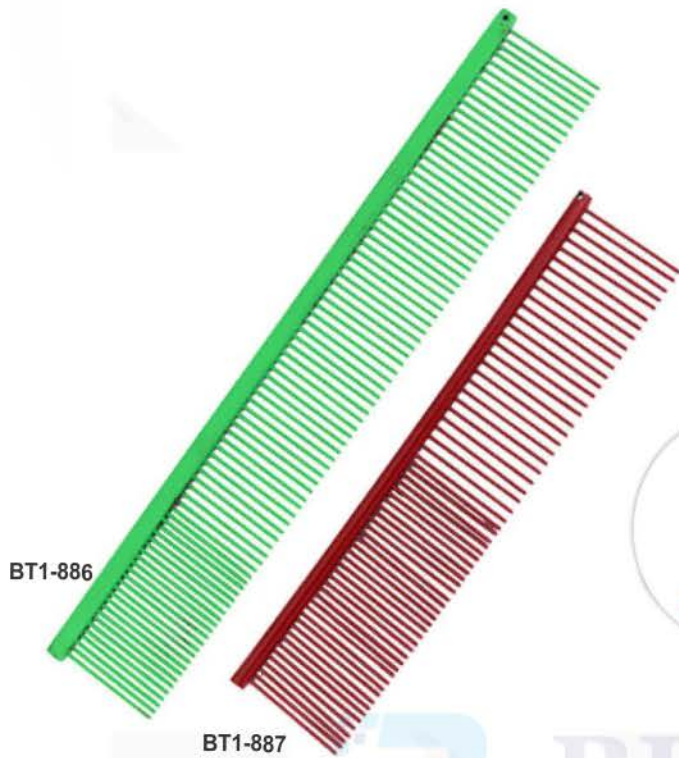

PET COMB



PET COMB





BT1-890

PET COMB



BT1-891





BT1-892



BT1-893



BT1-894

BT1-895



BT1-896

Dog Nail Cutter



BT1-897

BT1-898

BT1-899



Mattle Stone



BT1-900

BT1-901



Nail File





Dog Coat Stripper



Dog Coat Stripper





Dog Coat Stripper



Dog Coat Stripper





Hoof Knife



Hoof Knife





BT1-914

BT1-915

Hoof Knife



Loop
BT1-916

BT1-917

Hoof Knife





Hoof Knife



Hoof Knife





BT1-923

Hoof Knife



BIRDTEK
MANUFACTURING CORPORATION
Serving Health Care



BT1-924

Hoof Knife





BT1-925
G.P.G. Original
long cylinder - 12cm
short cylinder - 12cm



BT1-926
G.P.G. Original
long cylinder - 12cm
short cylinder - 12cm



BT1-927
G.P.G. Pro-grip Stirrups
12cm
with special grip sole.



BT1-928
G.P.G. Pro-grip Stirrups
Double Safety
12cm
These safety stirrups are
double asymmetrical,
have a special grip sole.
Used for eventing and
icelander.



BT1-929
Stirrups
9.5cm
N.P., Closed
metal sole.

BT1-930
Stirrups
12cm
N.P., With
white sole.

BT1-931
Stirrups
10-11-12cm
N.P., Open
bottom.

BT1-932
Stirrups Filles
11-12cm
C.P., With
white sole.



BT1-935
Filles Stirrups
11-12cm
S.S. With black
sole.

BT1-936
Stirrups
Filles Flex
12cm
with hinged
foot, S.S.

BT1-937
Safety Stirrups
10-12cm
S.S. With rubber
ring, elastic
and open
bottom.

BT1-938
kwik Out
Safety Stirrups
11-12cm
S.S.

BT1-939
H.S. Safety
Stirrups
11-12-13cm
S.S. Flexible
foot part.

BT1-940
Safety Stirrups
12cm
S.S., Double
asymmetric
stirrup with
sole. Often
used for icelander

BT1-941
Metalab Stirrups
11-12cm
S.S., with swivelled-eye
and hinged foot.



BT1-934
Stirrups Filles
12cm
AGT, with
white sole.



BT1-942
Robert EggButt Snaffle
13.5cm
Dr. Bristol, double jointed, S.S.



BT1-947
Robert Ring Snaffle Bit
12.5 - 13.5cm
hollow, 2 extra rings, S.S.



BT1-943
EggButt Snaffle
12.5-13.5-14.5cm
AGT, Thick.



BT1-948
Nathe Ring Snaffle Bit
13.5cm
with 2 extra rings and flexible steel reinforcement.



BT1-944
EggButt Snaffle
13.5cm
Rubber, with flat rings, S.S.



BT1-949
Nathe Ring Snaffle Bit
13.5cm
with 3 extra rings and flexible steel reinforcement.



BT1-945
Happy Mouth EggButt Snaffle
11.5-12.5-13.5cm
pony size, with small S.S. Rings.



BT1-950
Happy Mouth Ring Snaffle
12,5-13,5-14,5 cm
Jointed mouth, with
3 extra S.S. rings.



BT1-946
Happy Mouth EggButt Snaffle
12.5-13.5cm
S.S. Rings.



BT1-951
Rubber Mouth Snaffle
13,5-14,5 cm
Flexible soft rubber black
mullen mouth, S.S. ring.



BT1-952
Robart Pelham
13,5 cm
Jointed rubber mouth, S.S.



BT1-956
Robart Bradoon
13-14-14,5 cm
Solid, ring snaffle,
S.S.



BT1-957
Kk Schooling Bit
13 cm
Thick, solid eggbutt snaffle,
for the transition from snaffle
to weymouth, aurigan.



BT1-953
Mullen Mouth Pelham
13,5 cm
Slightly bent, soft rubber S.S.



BT1-958
Robart Western Reining Bit
12,5 cm
Pinchless western training
bit, joined mouth, S.S.



BT1-954
Robart Kimblewick Bit
14 cm
Jointed mouth S.S.



BT1-959
Robart Pro Reiner
12,5 cm
Pinchless western training
bit, S.S., Jointed mouth, S.S.
Ball and copper inlay.



BT1-955
K.K. Weymouth Bit
13.5cm
with double port mouth,
fixed cheeks, curb chain,
thick, solid, 18mm.,
Aurigan



BT1-960
Reining Horse Bit
12,5 cm
If your horse likes a snaffle,
but his mouth is feeling
numb, try this three piece
snaffle. It breaks over the
bars in a different place
creating a new feel. The
copper roller keeps the
mouth moist for a better feel.



BT1-961



BT1-962



BT1-963



BT1-964



BT1-965



BT1-966

BT1-967

Economic Country General Purpose Saddle

16" - 17" - 18" - havana, black

This saddle has a deep seat, leather knee pads and knee rolls.

BT1-968

Economic Junior General Purpose Saddle

15" - havana, black

This saddle has a deep seat, leather knee pads and knee rolls.

BT1-969

Economic Flexi Pony Saddle

15" - havana, black

This leather pony saddle with safety catches has no tree and fits almost on every pony. Ideal saddle for young riders.

BT1-970

Economic General Purpose Saddle

16" - havana, 18" - black

This saddle has soufflé pannels, knee rolls and leather kneepads.

BT1-971

Economic General Purpose Saddle

16" - 17" - 18" - black

This saddle has a deep seat, leather knee pads and adjustable knee rolls with Velcro.

BT1-972

Economic Pony Saddle

havana, black

This saddle is made of leather with felt. Supplied with girth and stirrup straps (stirrups not included). Perfect for young riders.



BT1-973



BT1-974



BT1-975



BT1-976



BT1-977



BT1-978



BT1-979



BT1-980



BT1-981



BT1-982

BT1-973

BR Jos Lansink Girth With Stud
125cm - 135cm - black, red, wood
With elastic on both ends and leather stud guard.
S.S. buckles

BT1-974

BR Classic Girth
105 up to 145cm - black
Leather padded girth and S.S. Buckles.

BT1-975

BR Leather Girth with Elastic
120 up to 145cm - Havana
110 up to 145cm - Black
Leather padded girth and S.S. Roller buckles.

BT1-976

BR Jos Lansink Girth
125cm - 135cm - black, red, wood
Pre-shaped girth with elastic on both ends with wide part in the middle. The girth has S.S. Buckles.

BT1-977

BR Jos Lansink Girth
125cm - 135cm - black, red, wood
Pre-shaped girth with elastic on both ends S.S. Buckles and a medicinally tanned sheepskin lining. During training you can replace the sheepskin lining for a neoprene lining. (Neoprene lining, art. 033 is not included)

BT1-978

BR Jos Lansink Girth With Stud Guard
125cm - 135cm - black, red, wood
With elastic on both ends, fixed leather stud guard, S.S. Buckles and a medicinally tanned sheepskin lining. During training you can replace the sheepskin lining for a neoprene lining (neoprene lining, art. 034 is not included).

BT1-979

BR Girth Lining
black
Neoprene, for the BR Jos Lansink girth art. 031.
Easily to attach with Velcro fastenings.

BT1-980

BR Girth Lining
black
Neoprene, for the BR Jos Lansink girth art. 032.
Easily to attach with Velcro fastenings.

BT1-981

BR Stud Guard
f/s - black
Leather stud guard, luxury, can easily be fastened to the girth, for jumpers.

BT1-982

BR Classic Stud Guard
f/s - havana, black
Leather lined with rubber, can easily be fastened to the girth, for jumpers.

BT1-983

BR Noseband
f/s - black
white lined dressage noseband,
English model with easy
tightening system and S.S. Buckles.

BT1-984

BR Noseband
f/s - xf/s - black
extra wide, lined flash noseband
with easy tightening system and
S.S. Buckles.

BT1-985

BR Noseband
f/s - black
Lined flash noseband with easy
tightening system and comfortable
jaw protector, S.S. Buckles.

BT1-986

Flash Noseband
f/s - Premiere, S.S. Buckles, havana,
black, lined
f/s - Economic, S.N. Buckles, black

BT1-987

BR Grackle Noseband
f/s - havana, black
With S.S. Buckles, the nose
part is lined with sheepskin

BT1-988

BR Grackle Noseband
f/s - black
white brass rings and buckles, the
nose part is lined with sheepskin.

BT1-989

BR Noseband
f/s - black
Raised square flash noseband with
brass buckles. For bridle.

BT1-990

BR Noseband
f/s - black
Raised square flash noseband with
S.S. buckles. For bridle.

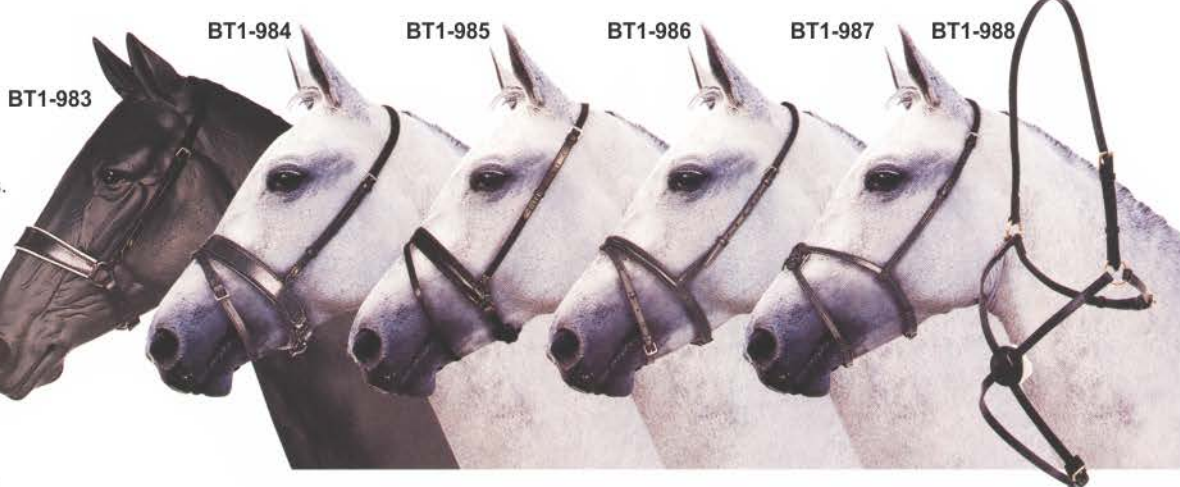

BT1-991

Premiere Noseband
f/s - p/s - c/s - black
wide flash noseband with easy
tightening system, raised and lined,
S.S. Buckles.

BT1-992

BR Dressage Noseband
f/s - black
wide soft lined noseband with
soft padded easy tightening
system, English model and with
a comfortable jaw protector.

BT1-993

BR Noseband
f/s - black
Rope cavesson noseband for
better interaction

BT1-994

BR Noseband
f/s - black
the cheek of this noseband gives
a better interaction if the horse
opens his mouth

BT1-995

Economic Noseband
f/s - black
Drop noseband.

BT1-996

BR Grackle Noseband
f/s - black
anatomically shaped nose part with
sheepskin lining.

BT1-997

Flash Noseband Attachment
f/s - havana, black
Buckles on to cavesson noseband, S.S.
Buckles.

BT1-998

Equitex Jaw Protector
black
Bultex, 10mm.

BT1-999

Jaw Protector
black
with alfa gel.

Noseband Cover

BT1-1000- christ - natural - 28cm
BT1-1001- chatelaine - acrylic fur
white , black, 27cm
BT1-1002- chatelaine sheep's wool
natural - 28cm





BT1-1003

BT1-1003
BR Western Bridle
272000 - f/s - blue, red, black
splendid, simple nylon bridle with s.s
buckles. The bridle will be delivered
with matching reins and a bit.



BT1-1004

BT1-1004
Tuffy Western Bridle
272500 - f/s - brown, black
5/8" double stitched premium soft
nylon with 1/2" phoenix overlay.
The bridle will be delivered with
reins and bit. Made in USA. Match
to article 279503.



BT1-1005



BT1-1007



BT1-1006



BT1-1008



BT1-1009



BT1-1005
big horn western bridle
272501 - f/s - show brown, golden tan
Double bridle with brass buckles.
5/8" wide. Made in USA.

BT1-1006
big horn western bridle
272502 - f/s - medium oil
this bridle with a knotted browband is
one of the most popular headstalls.
Made of 5/8" single ply-stitched harness
leather, hand finished with solid brass
buckles. Made in USA.

BT1-1007
big horn ear bridle
272503 - f/s - show brown, golden tan
single ply-stitched slip ear headstall.
Made in USA.

BT1-1008
big horn western show bridle
272504 - f/s - golden tan
Splendid western show bridle, luxurious
model. Knotted browband, mounted
with silver plated trim and enhanced
with jewellers bronze bars. The straps
are hand-rubbered, double stitched with
stained edges. Made in USA. Can be
ordered with matching reins, art. 279508

BT1-1009
Big Horn Side Pull Bridle
272505 - f/s - medium oil
Heavy 5/8" single-ply, handlace harness
leather headstall with latigo curb strap
hand tied nylon lariat rope noseband.
The second ring for reins allows the
nose band to roll across a horse's nose
giving better head position. Ideal for
training. Made in USA.



BT1-1010

BT1-1010
Royal western ear headstall
272002 - f/s - black
with coloured ornaments
and leather reins.

BT1-1011
Royal western headstall
272001 - f/s - havana, black
western weymouth headstall
in rolled leather, with reins.



BT1-1011

BT1-1012

Fleck Dressage Whip
120 cm. black
lacquered fibreglass, with luxury bam-boo grip ad a nickel button.

BT1-1014

Dressage Whip
95 cm.- black
lacquered fibreglass, with a horse head button.

BT1-1018

Dressage Whip
100 - 110 - 120cm - blue, red, black
Fibreglass, nylon thread stem, synthetic button.

BT1-1019

Ascot Dressage Whip
100 - 110 - 120cm - grey
nylon stem, black grip, silver-coloured button

BT1-1013

Dressage Whip
100 cm.- black
lacquered fibreglass, with a horse head button.

BT1-1015

Snowbee Jumping Bat
52cm - black, green, blue, black, pink, blue, black, yellow, red.
PVC stem, leather "hand" shaped keeper.

**BT1-1019
BT1-1020**

BT1-1021

BT1-1020

Dressage Whip
100 - 110 - 120cm - black, black-white
Fibreglass, nylon thread stem, synthetic grip.

BT1-1021

Dressage Whip
100 - 110 - 120cm - black
Fibreglass, lacquered, white leather grip, silver colored button.

BT1-1016

Jumping Bat
65cm - green, blue, black, red.
Rubber non skid grip and leather keeper.

BT1-1017

Fleck Jumping Bat
65cm - black
Fibreglass, nylon thread stem, rubber grip, leather keeper.

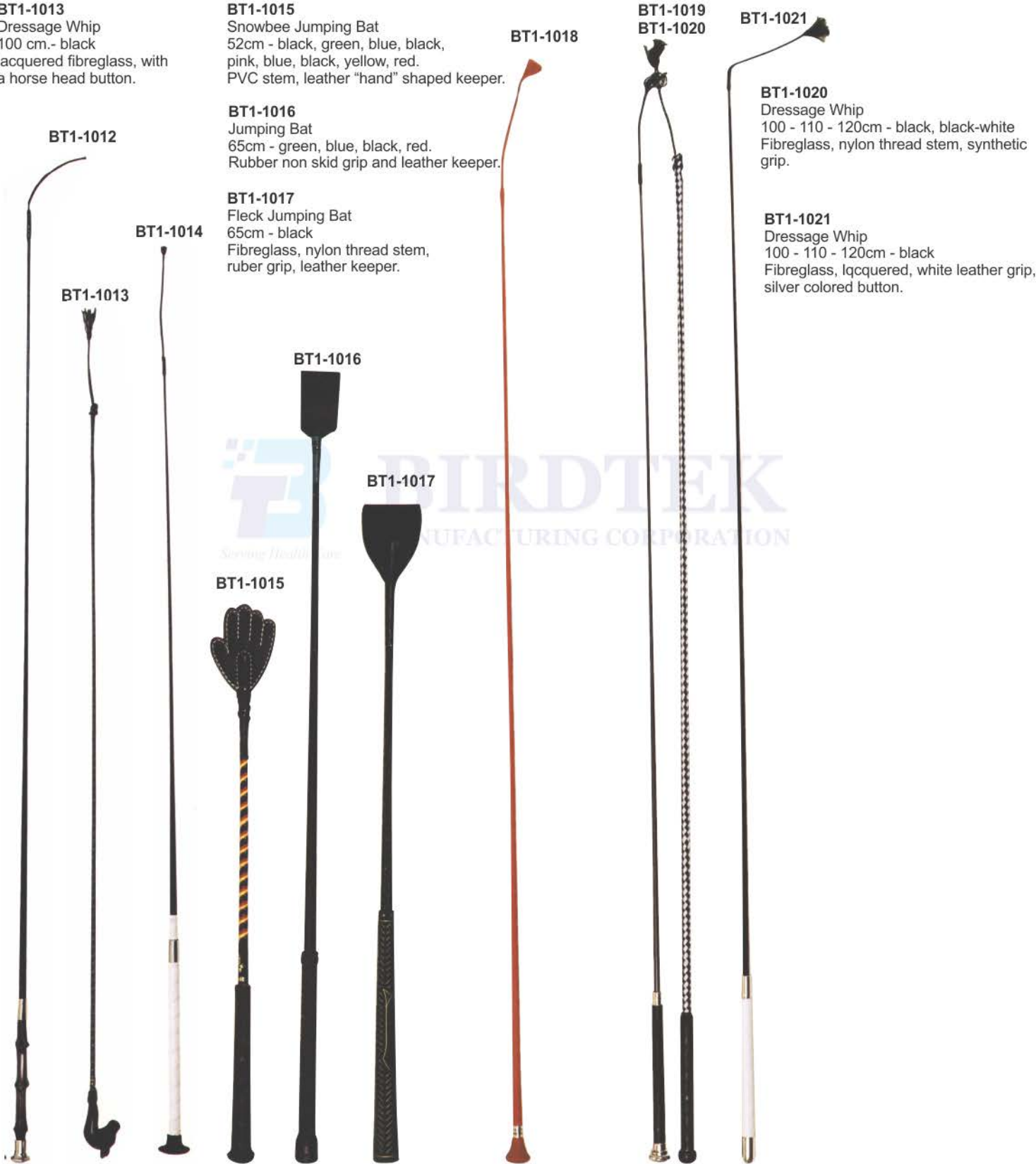

BT1-1022
Snowbee Riding Whip
75-90cm - Black, Black-White
Fibreglass, nylon thread stem, synthetic
grip and wrist loop.

BT1-1023
Riding Whip
75cm - Brown, Black, Black-White
Fibreglass, nylon thread stem
with PVC grip and wrist loop.

BT1-1024
Riding Whip
65cm - Blue, Brown, Green, Red,
Black, Purple.
nylon thread stem, Fancy nylon
wrist loop and keeper.

BT1-1025
Riding Whip
56cm - Blue, Light-blue, Pink-black
Fiberglass, Nylon thread stem with
synthetic grip & leather hand shaped,
& keeper.

BT1-1026
Riding Whip
70cm - Brown, Black
Pleated leather covered Nylon stem,
leather wrist loop & keeper.

BT1-1027
Fleck Riding Whip
80cm - Black
Fiberglass, Nylon thread stem,
synthetic wrist loop & PVC button.

BT1-1022

BT1-1023

BT1-1024

BT1-1026

BT1-1025

BT1-1027



Deerskin

The BR riding gloves are made of deerskin. The hides are extra thick, elastic and supple. These gloves fit perfectly and comfortably. The gloves can be hand washed in lukewarm water with a soft detergent.



BT1-1028
BR Riding Gloves
6 up to 10 - black
Luxury riding glove made of deerskin, without lining. In luxurious packing.

BT1-1029
BR Riding Gloves
6 up to 9 - black
Exclusive, warm riding glove made of deerskin, with a cotton lining and finger reinforcements.

BT1-1030
BR Riding Gloves
6.5 up to 10 - white
Luxury show riding glove made of deerskin, with a velcro fastening wrist strap, without lining.

BT1-1031
BR Riding Gloves
7 up to 9.5 - natural
Made of deerskin, without lining.

BT1-1032
BR Riding Gloves
XS-S-M-L-XL - black
Traditional pigskin riding glove with demi-crochet back, lined with wool.

BT1-1033
BR Riding Gloves
XS-S-M-L-XL - brown
Traditional pigskin riding glove with demi-crochet back, without lining.

BT1-1034
BR Driving Gloves
7 up to 12 - natural
Made from Canadian deerskin, unlined, with finger reinforcements and velcro wrist fastening at the wrist.

BT1-1035
Premiere Winter Riding Glove
XS-S-M-L-XL - black
warm winter glove made of neat's leather and lined with fleece, velcro wrist fastening.

BT1-1036
Riding Glove
XXS-XS-S-M-L-XL - brown
Riding glove made of neat's leather with crochet polyester/cotton back.

BT1-1037
Royal Riding Glove
XS-S-M-L-XL - brown
Strong glove made of neat's leather with suede back and velcro wrist fastening.

BT1-1038
Winter Riding Glove
7 up to 9.5 - brown
Warm winter riding glove made of pigskin, fleece lining and velcro wrist fastening.

BT1-1039
Riding Glove
XS-S-M-L-XL - black
Riding glove made of soft and supple sheepskin, unlined with velcro wrist fastening.

BT1-1040
Riding Glove
XS-S-M-L-XL - black
Glove made of neat's leather with spandex back with velcro wrist fastening.

BT1-1041
Driving Glove
S-M-L-XL-XXL - black
Unlined, neat's leather driving glove with velcro wrist fastening.



BT1-1042
Riding Glove
XS-S-M-L-XL - Blue, Brown, Green, White, Black, grey, Burgundy, Ochre.
Cotton glove with pimple palm, finger reinforcements and velcro wrist fastening.

BT1-1043
BR Riding Glove all weather
XXS-XS-S-M-L-XL-XXL - Blue, White, Black
riding glove made of PU. Coated micro fiber and with a non-skid palm, these are the most leather-like in feel gloves. Supply to wear and easy maintenance.

BT1-1044
BR Riding Glove Amara
XS-S-M-L-XL - Brown, White, Black
soft micro fiber glove, breathable, washable 30°C.

BT1-1045
BR Riding Glove Digital
XXS-XS-S-M-L-XL-XXL - White, Black
Made of PU. Coated micro fiber and with a non-skid palm. These are the most leather-like in feel gloves. Supply to wear and easy maintenance.

BT1-1046
BR Riding Glove
XS-S-M-L-XL - Black
a fine artificial leather glove with fleece back and velcro wrist fastening.

BT1-1047
Premiere Winter Riding Glove
XXS-XS-S-M-L-XL - Blue, Green, strong, warm fleece glove, reinforced with artificial leather.

BT1-1048
Premiere Winter Riding Glove
Thinsulate
S-M-L-XL - Green,
very warm riding glove with velcro fastening. This glove is wind & waterproof and made of breathable material.

BT1-1049
Winter Riding Glove
Blue, Green, black
strong, elastic winter glove.
One size, fits and hand.

BT1-1050
Magic Glove (Adults)
Blue, Green, red, White, Black, Burgundy, Purple, multi-colour elastic glove with pimple palm for extra grip. One size, fits and hand.

BT1-1051
Magic Glove (Children)
Blue, red, White, Black, Burgundy, Purple, multi-colour elastic glove with pimple palm for extra grip.
One size, fits and hand.

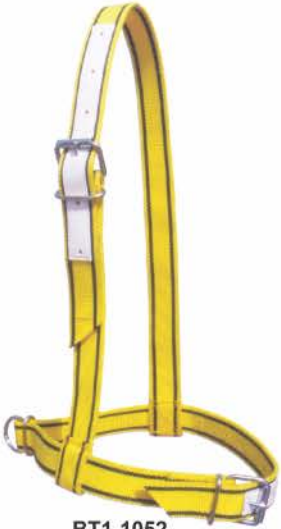

BT1-1052
Cow Halter Nylon

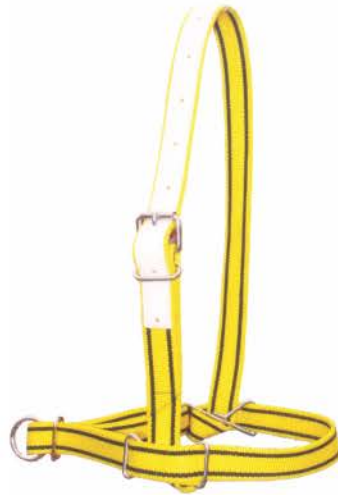

BT1-1053
Cow Halter Nylon
Adjustable on Headpiece
and noseband



BT1-1054
Cow Halter Nylon
Adjustable on Headpiece
and noseband



BT1-1055
Cow Halter with chain,
Adjustable Headpiece



BT1-1056
Bull Halter For Extra Big Bulls
Adjustable on Headpiece
and noseband



BT1-1057
Cow Halter-Leather
Adjustable on Headpiece
and noseband



BT1-1058
Sheep Halter Leather



BT1-1059
Sheep Halter Leather



BT1-1060
Calf Collar Nylon
Adjustable on Headpiece and noseband



BT1-1061
Sheep Halter Leather



BT1-1062
Sheep Halter Leather



BT1-1063
Sheep Collar Nylon



BT1-1064
Sheep Collar Nylon with swivel



BT1-1065
Calf Collar Nylon
with swivel



BT1-1066 Calf Collar Leather with swivel

BT1-1067 Calf Collar Leather with swivel

BT1-1068
Calf Collar Leather with Chain



BT1-1069
Calf Collar 90cm
Nylon with Chain



BT1-1070
Calf Collar 90cm
Nylon with Chain



BT1-1071
Band Double
with Chain

BT1-1072
Band Single
with Chain



BT1-1073
Cattle Hobble Nylon
With Neoprene Foam Padding



BT1-1074
Cattle Hobble made of
Soft Padded Webbing

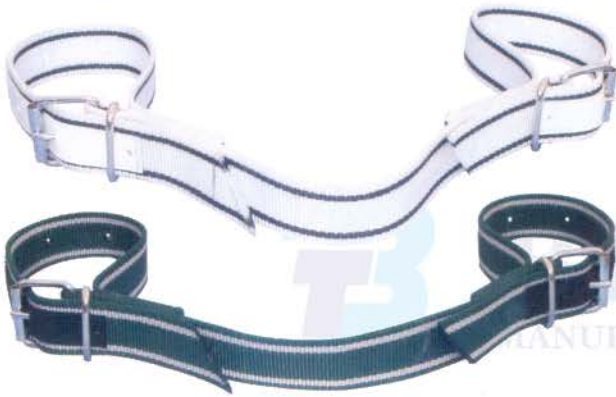

BT1-1075
Cattle Hobble Nylon



BT1-1076
Cattle Hobble-Leather



BT1-1077
Cattle Hobble
Figure 8-Leather



BT1-1078
Cattle Hobble Nylon Adjustable



BT1-1079
Sheep Bell
with Nylon Belt



BT1-1080
Cow Bell
American Style



BT1-1081
Cow Bell
German Style



BT1-1082
Cow Bell



BT1-1083
Tool Belt Leather



BT1-1084
Tool Belt Leather

BT1-1085
Splint Forceps, 10cm



BT1-1086
Backhaus Towel Forceps

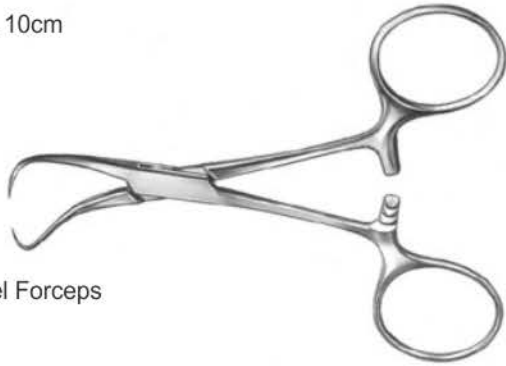

BT1-1087
Haemostatic Forceps
T-shaped, 16cm



BT1-1088
Metzemabaum Scissors



BT1-1089
Mayo Scissors



BT1-1090
Utility Scissors
19cm

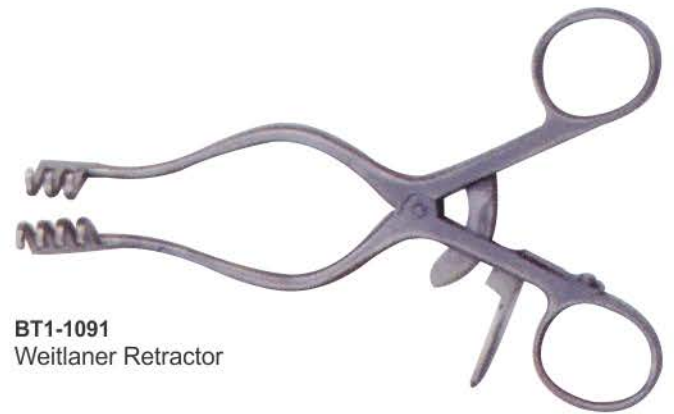

BT1-1091
Weitlaner Retractor



BT1-1092



BT1-1093
Mathieu Needle Holder



BT1-1094
Mathieu Needle
Holder Tungstene Jaws

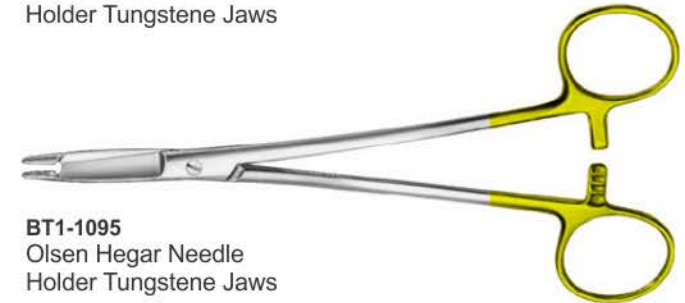

BT1-1095
Olsen Hegar Needle
Holder Tungstene Jaws



BT1-1096
Gynecological Instruments

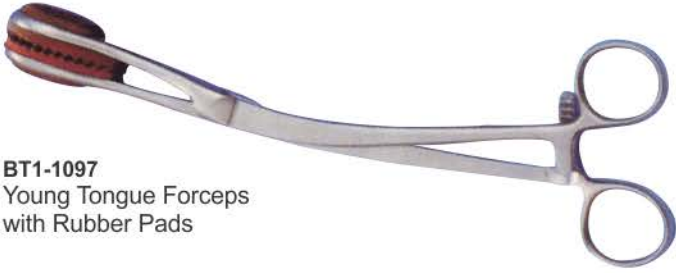

BT1-1097
 Young Tongue Forceps
 with Rubber Pads

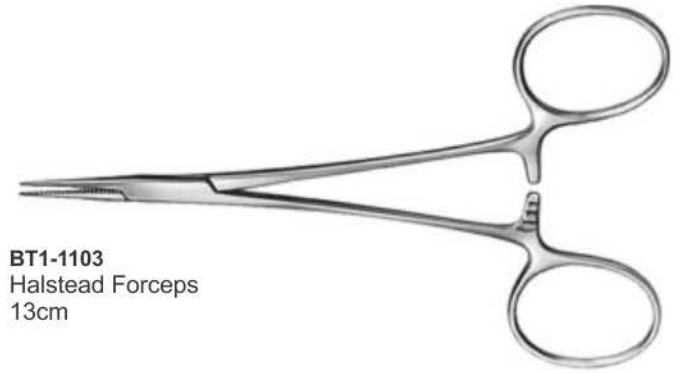

BT1-1103
 Halstead Forceps
 13cm



BT1-1098
 Baby Tongue Forceps
 with Rubber Pads



BT1-1104
 Hartmann Forceps, 14cm



BT1-1099
 Doyen Intestinal
 Clamp, 23cm



Cushing Forceps
BT1-1105
 17cm 6 3/4"



BT1-1100
 Crile-Wood
 Needle Holder, 15cm



Splinter Forceps
BT1-1106
 12.5cm



Gillies
BT1-1101
 16cm



Dissecting Forceps
BT1-1107
 13cm



BT1-1102
 Olsen Hegar
 Needle Holder



Troeltsch (Wilde)
Ear Forceps
BT1-1108
 10.5cm 4 1/8"



Kocher Forceps
 with teeth
BT1-1109
 14.5cm



Pean (Rochester)
BT1-1110
 14.5cm



Pean Haemostatic Forceps
BT1-1111 14.5cm 5 3/4"
BT1-1112 16cm 6 1/4"

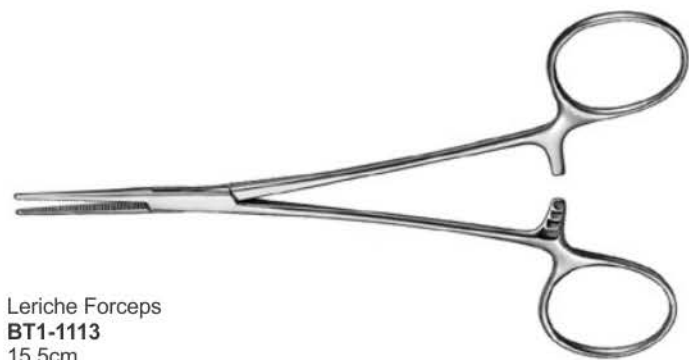

Leriche Forceps
BT1-1113
 15.5cm

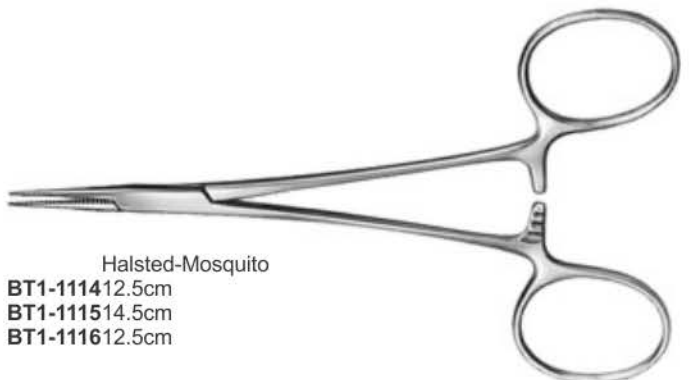

Halsted-Mosquito
BT1-1114 12.5cm
BT1-1115 14.5cm
BT1-1116 12.5cm

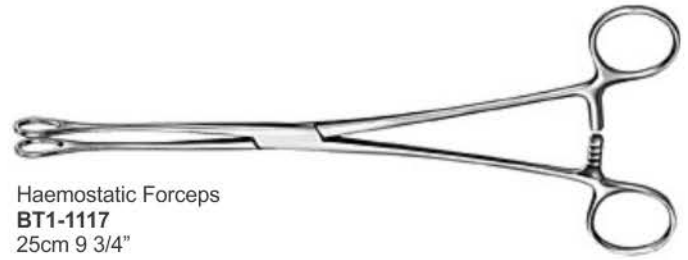

Haemostatic Forceps
BT1-1117
 25cm 9 3/4"

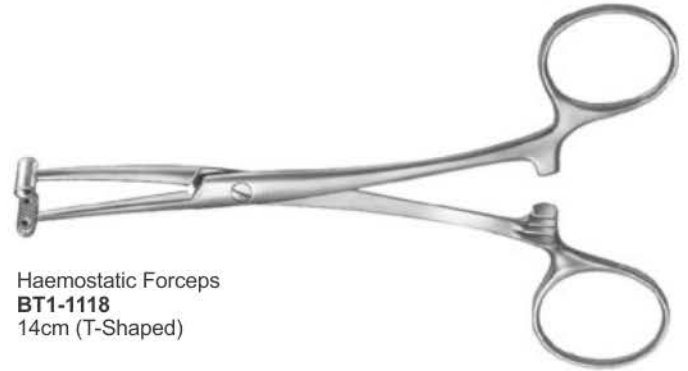

Haemostatic Forceps
BT1-1118
 14cm (T-Shaped)

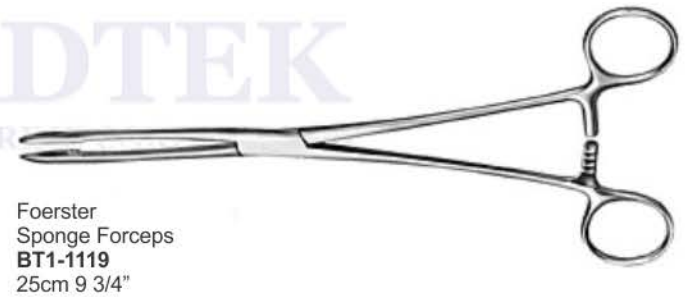

Foerster
 Sponge Forceps
BT1-1119
 25cm 9 3/4"

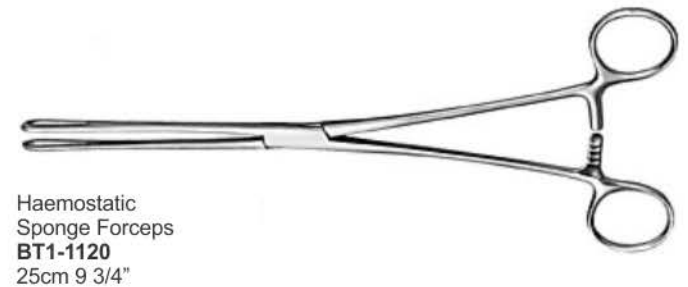

Haemostatic
 Sponge Forceps
BT1-1120
 25cm 9 3/4"

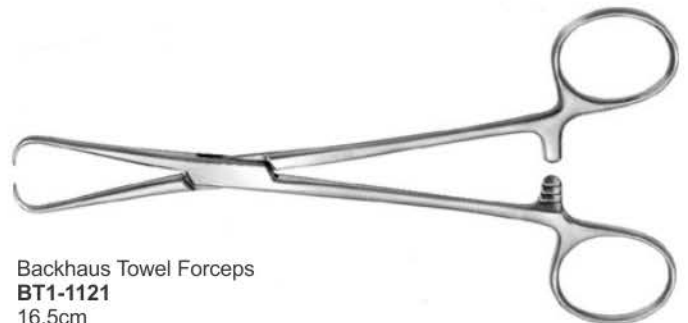

Backhaus Towel Forceps
BT1-1121
 16.5cm





Serving Health Care

BIRDTEK

MANUFACTURING CORPORATION

Manufacturers & Exporters of Quality Veterinary Instruments

 **160/C, Small Industrial Estate
Sialkot-51310, (Pakistan)**

 **+92-52-3555548**

 **+92-52-3553683**

 **info@birdtekcorp.com**

 **www.birdtekcorp.com**